

***Consultative
Committee for
Space Data Systems***

**RECOMMENDATION FOR SPACE
DATA SYSTEM STANDARDS**

**AOS SPACE DATA
LINK PROTOCOL**

CCSDS 732.0-B-1

BLUE BOOK

September 2003

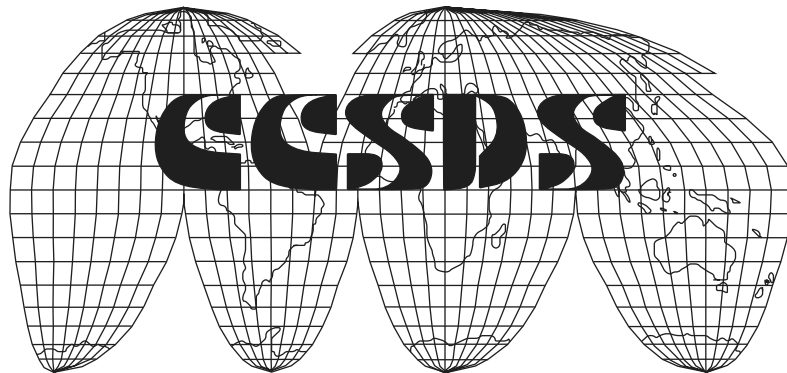

AUTHORITY

| | |
|-----------|--------------------|
| Issue: | Blue Book, Issue 1 |
| Date: | September 2003 |
| Location: | Not Applicable |

This document has been approved for publication by the Management Council of the Consultative Committee for Space Data Systems (CCSDS) and represents the consensus technical agreement of the participating CCSDS Member Agencies. The procedure for review and authorization of CCSDS Recommendations is detailed in reference [B1], and the record of Agency participation in the authorization of this document can be obtained from the CCSDS Secretariat at the address below.

This Recommendation is published and maintained by:

CCSDS Secretariat
Office of Space Communication (Code M-3)
National Aeronautics and Space Administration
Washington, DC 20546, USA

STATEMENT OF INTENT

The Consultative Committee for Space Data Systems (CCSDS) is an organization officially established by the management of member space Agencies. The Committee meets periodically to address data systems problems that are common to all participants, and to formulate sound technical solutions to these problems. Inasmuch as participation in the CCSDS is completely voluntary, the results of Committee actions are termed **Recommendations** and are not considered binding on any Agency.

This **Recommendation** is issued by, and represents the consensus of, the CCSDS Plenary body. Agency endorsement of this **Recommendation** is entirely voluntary. Endorsement, however, indicates the following understandings:

- Whenever an Agency establishes a CCSDS-related **standard**, this **standard** will be in accord with the relevant **Recommendation**. Establishing such a **standard** does not preclude other provisions which an Agency may develop.
- Whenever an Agency establishes a CCSDS-related standard, the Agency will provide other CCSDS member Agencies with the following information:
 - The **standard** itself.
 - The anticipated date of initial operational capability.
 - The anticipated duration of operational service.
- Specific service arrangements are made via memoranda of agreement. Neither this Recommendation nor any ensuing standard is a substitute for a memorandum of agreement.

No later than five years from its date of issuance, this **Recommendation** will be reviewed by the CCSDS to determine whether it should: (1) remain in effect without change; (2) be changed to reflect the impact of new technologies, new requirements, or new directions; or, (3) be retired or canceled.

In those instances when a new version of a **Recommendation** is issued, existing CCSDS-related Agency standards and implementations are not negated or deemed to be non-CCSDS compatible. It is the responsibility of each Agency to determine when such standards or implementations are to be modified. Each Agency is, however, strongly encouraged to direct planning for its new standards and implementations towards the later version of the Recommendation.

FOREWORD

This document is a technical Recommendation for use in developing flight and ground systems for space missions and has been prepared by the Consultative Committee for Space Data Systems (CCSDS). The Advanced Orbiting Systems (AOS) Space Data Link Protocol described herein is intended for missions that are cross-supported between Agencies of the CCSDS.

This Recommendation specifies a communications protocol to be used by space missions to transfer space application data over ground-to-space or space-to-space communications links. This Recommendation is developed from the specifications of the Data Link Layer portion of an older CCSDS Recommendation (reference [B2]), which defines essentially the same protocol and services but in a slightly different context.

This Recommendation does not change the major technical contents defined in reference [B2], but the presentation of the specification has been changed so that:

- a) this protocol can be used to transfer any data over any space link in either direction;
- b) all CCSDS space link protocols are specified in a unified manner;
- c) the specification matches the OSI Basic Reference Model (references [1] and [2]).

Together with the change in presentation, a few technical specifications in reference [B2] have been changed in order to define all Space Data Link Protocols in a unified way. Also, some technical terms in reference [B2] have been changed in order to unify the terminology used in all the CCSDS Recommendations that define space link. These changes are listed in annex C of this Recommendation.

Through the process of normal evolution, it is expected that expansion, deletion or modification to this document may occur. This Recommendation is therefore subject to CCSDS document management and change control procedures, as defined in reference [B1]. Current versions of CCSDS documents are maintained at the CCSDS Web site:

<http://www.ccsds.org/>

Questions relating to the contents or status of this document should be addressed to the CCSDS Secretariat at the address indicated on page i.

At time of publication, the active Member and Observer Agencies of the CCSDS were:

Member Agencies

- Agenzia Spaziale Italiana (ASI)/Italy.
- British National Space Centre (BNSC)/United Kingdom.
- Canadian Space Agency (CSA)/Canada.
- Centre National d’Etudes Spatiales (CNES)/France.
- Deutsches Zentrum für Luft- und Raumfahrt e.V. (DLR)/Germany.
- European Space Agency (ESA)/Europe.
- Instituto Nacional de Pesquisas Espaciais (INPE)/Brazil.
- National Aeronautics and Space Administration (NASA)/USA.
- National Space Development Agency of Japan (NASDA)/Japan.
- Russian Space Agency (RSA)/Russian Federation.

Observer Agencies

- Austrian Space Agency (ASA)/Austria.
- Central Research Institute of Machine Building (TsNIIMash)/Russian Federation.
- Centro Tecnico Aeroespacial (CTA)/Brazil.
- Chinese Academy of Space Technology (CAST)/China.
- Commonwealth Scientific and Industrial Research Organization (CSIRO)/Australia.
- Communications Research Laboratory (CRL)/Japan.
- Danish Space Research Institute (DSRI)/Denmark.
- European Organization for the Exploitation of Meteorological Satellites (EUMETSAT)/Europe.
- European Telecommunications Satellite Organization (EUTELSAT)/Europe.
- Federal Service of Scientific, Technical & Cultural Affairs (FSST&CA)/Belgium.
- Hellenic National Space Committee (HNSC)/Greece.
- Indian Space Research Organization (ISRO)/India.
- Institute of Space and Astronautical Science (ISAS)/Japan.
- Institute of Space Research (IKI)/Russian Federation.
- KFKI Research Institute for Particle & Nuclear Physics (KFKI)/Hungary.
- MIKOMTEK: CSIR (CSIR)/Republic of South Africa.
- Korea Aerospace Research Institute (KARI)/Korea.
- Ministry of Communications (MOC)/Israel.
- National Oceanic & Atmospheric Administration (NOAA)/USA.
- National Space Program Office (NSPO)/Taipei.
- Space and Upper Atmosphere Research Commission (SUPARCO)/Pakistan.
- Swedish Space Corporation (SSC)/Sweden.
- United States Geological Survey (USGS)/USA.

DOCUMENT CONTROL

| Document | Title and Issue | Date | Status |
|--------------------|--|-------------------|----------------|
| CCSDS 732.0-B-1 | AOS Space Data Link Protocol, Issue 1 | September 2003 | Original Issue |

CONTENTS

| <u>Section</u> | <u>Page</u> |
|--|-------------|
| 1 INTRODUCTION | 1-1 |
| 1.1 PURPOSE..... | 1-1 |
| 1.2 SCOPE..... | 1-1 |
| 1.3 APPLICABILITY..... | 1-1 |
| 1.4 RATIONALE..... | 1-2 |
| 1.5 DOCUMENT STRUCTURE..... | 1-2 |
| 1.6 CONVENTIONS AND DEFINITIONS..... | 1-2 |
| 1.7 REFERENCES..... | 1-5 |
| 2 OVERVIEW | 2-1 |
| 2.1 CONCEPT OF AOS SPACE DATA LINK PROTOCOL..... | 2-1 |
| 2.2 OVERVIEW OF SERVICES..... | 2-3 |
| 2.3 OVERVIEW OF FUNCTIONS..... | 2-10 |
| 2.4 SERVICES ASSUMED FROM LOWER LAYERS..... | 2-12 |
| 3 SERVICE DEFINITION | 3-1 |
| 3.1 OVERVIEW..... | 3-1 |
| 3.2 SOURCE DATA..... | 3-1 |
| 3.3 PACKET SERVICE..... | 3-3 |
| 3.4 BITSTREAM SERVICE..... | 3-6 |
| 3.5 VIRTUAL CHANNEL ACCESS (VCA) SERVICE..... | 3-9 |
| 3.6 VIRTUAL CHANNEL OPERATIONAL CONTROL FIELD (VC_OCF) SERVICE..... | 3-12 |
| 3.7 VIRTUAL CHANNEL FRAME (VCF) SERVICE..... | 3-15 |
| 3.8 MASTER CHANNEL FRAME (MCF) SERVICE..... | 3-18 |
| 3.9 INSERT SERVICE..... | 3-20 |
| 4 PROTOCOL SPECIFICATION | 4-1 |
| 4.1 PROTOCOL DATA UNIT..... | 4-1 |
| 4.2 PROTOCOL PROCEDURES AT THE SENDING END..... | 4-16 |
| 4.3 PROTOCOL PROCEDURES AT THE RECEIVING END..... | 4-22 |
| 5 MANAGED PARAMETERS | 5-1 |
| 5.1 OVERVIEW OF MANAGED PARAMETERS..... | 5-1 |
| 5.2 MANAGED PARAMETERS FOR A PHYSICAL CHANNEL..... | 5-1 |
| 5.3 MANAGED PARAMETERS FOR A MASTER CHANNEL..... | 5-2 |
| 5.4 MANAGED PARAMETERS FOR A VIRTUAL CHANNEL..... | 5-2 |

CONTENTS (continued)

| <u>Section</u> | <u>Page</u> |
|--|-------------|
| 5.5 MANAGED PARAMETERS FOR PACKET TRANSFER..... | 5-3 |
| ANNEX A ACRONYMS..... | A-1 |
| ANNEX B INFORMATIVE REFERENCES | B-1 |
| ANNEX C CHANGES FROM REFERENCE [B2] | C-1 |

Figure

| | |
|--|------|
| 1-1 Bit Numbering Convention..... | 1-5 |
| 2-1 Relationship with OSI Layers..... | 2-1 |
| 2-2 Relationships between Channels | 2-3 |
| 2-3 Asynchronous Service Model..... | 2-5 |
| 2-4 Synchronous Service Model | 2-6 |
| 2-5 Internal Organization of Protocol Entity (Sending End) | 2-11 |
| 2-6 Internal Organization of Protocol Entity (Receiving End) | 2-11 |
| 2-7 AOS Space Data Link Protocol Channel Tree..... | 2-12 |
| 4-1 AOS Transfer Frame Structural Components..... | 4-2 |
| 4-2 Transfer Frame Primary Header | 4-2 |
| 4-3 Multiplexing Protocol Data Unit (M_PDU) | 4-9 |
| 4-4 Bitstream Protocol Data Unit (B_PDU) | 4-12 |
| 4-5 Internal Organization of Protocol Entity (Sending End) | 4-16 |
| 4-6 Abstract Model of Packet Processing Function..... | 4-17 |
| 4-7 Abstract Model of Bitstream Processing Function | 4-18 |
| 4-8 Abstract Model of Virtual Channel Generation Function | 4-19 |
| 4-9 Abstract Model of Virtual Channel Multiplexing Function | 4-20 |
| 4-10 Abstract Model of Master Channel Multiplexing Function..... | 4-21 |
| 4-11 Abstract Model of All Frames Generation Function | 4-22 |
| 4-12 Internal Organization of Protocol Entity (Receiving End) | 4-23 |
| 4-13 Abstract Model of Packet Extraction Function..... | 4-24 |
| 4-14 Abstract Model of Bitstream Reception Function | 4-25 |
| 4-15 Abstract Model of Virtual Channel Reception Function..... | 4-26 |
| 4-16 Abstract Model of Virtual Channel Demultiplexing Function | 4-27 |
| 4-17 Abstract Model of Master Channel Demultiplexing Function | 4-28 |
| 4-18 Abstract Model of All Frames Reception Function..... | 4-29 |

Table

| | |
|--|-----|
| 2-1 Summary of Services Provided by AOS Space Data Link Protocol | 2-7 |
| 5-1 Managed Parameters for a Physical Channel | 5-1 |
| 5-2 Managed Parameters for a Master Channel..... | 5-2 |
| 5-3 Managed Parameters for a Virtual Channel..... | 5-2 |
| 5-4 Managed Parameters for Packet Transfer..... | 5-3 |
| C-1 Mapping of Terms That Have Been Redefined..... | C-3 |

1 INTRODUCTION

1.1 PURPOSE

The purpose of this Recommendation is to specify the Advanced Orbiting Systems (AOS) Space Data Link Protocol. This protocol is a Data Link Layer protocol (see reference [1]) to be used over space-to-ground, ground-to-space, or space-to-space communications links by space missions.

1.2 SCOPE

This Recommendation defines the AOS Space Data Link Protocol in terms of:

- a) the services provided to the users of this protocol;
- b) the protocol data units employed by the protocol; and
- c) the procedures performed by the protocol.

It does not specify:

- a) individual implementations or products;
- b) the implementation of service interfaces within real systems;
- c) the methods or technologies required to perform the procedures; or
- d) the management activities required to configure and control the protocol.

1.3 APPLICABILITY

This Recommendation applies to the creation of Agency standards and to future data communications over space links between Consultative Committee for Space Data Systems (CCSDS) Agencies in cross-support situations. The Recommendation includes comprehensive specification of the services and protocol for inter-Agency cross support. It is neither a specification of, nor a design for, real systems that may be implemented for existing or future missions.

The Recommendation specified in this document is to be invoked through the normal standards programs of each CCSDS Agency and is applicable to those missions for which cross support based on capabilities described in this Recommendation is anticipated. Where mandatory capabilities are clearly indicated in sections of the Recommendation, they must be implemented when this document is used as a basis for cross support. Where options are allowed or implied, implementation of these options is subject to specific bilateral cross support agreements between the Agencies involved.

1.4 RATIONALE

The CCSDS believes it is important to document the rationale underlying the recommendations chosen, so that future evaluations of proposed changes or improvements will not lose sight of previous decisions.

1.5 DOCUMENT STRUCTURE

This document is divided into five numbered sections and three annexes:

- a) section 1 presents the purpose, scope, applicability and rationale of this Recommendation and lists the conventions, definitions, and references used throughout the Recommendation;
- b) section 2 provides an overview of the AOS Space Data Link Protocol;
- c) section 3 defines the services provided by the protocol entity;
- d) section 4 specifies the protocol data units and procedures employed by the protocol entity;
- e) section 5 specifies the managed parameters used by the protocol entity;
- f) annex A lists all acronyms used within this document;
- g) annex B provides a list of informative references;
- h) annex C lists the changes from the older CCSDS Recommendation (reference [B2]).

1.6 CONVENTIONS AND DEFINITIONS

1.6.1 DEFINITIONS

1.6.1.1 Definitions from the Open Systems Interconnection (OSI) Basic Reference Model

This Recommendation makes use of a number of terms defined in reference [1]. The use of those terms in this Recommendation shall be understood in a generic sense; i.e., in the sense that those terms are generally applicable to any of a variety of technologies that provide for the exchange of information between real systems. Those terms are:

- a) blocking;
- b) connection;
- c) Data Link Layer;
- d) entity;
- e) flow control;

- f) Network Layer;
- g) peer entities;
- h) Physical Layer;
- i) protocol control information;
- j) protocol data unit;
- k) real system;
- l) segmenting;
- m) service;
- n) Service Access Point (SAP);
- o) SAP address;
- p) service data unit.

1.6.1.2 Definitions from OSI Service Definition Conventions

This Recommendation makes use of a number of terms defined in reference [2]. The use of those terms in this Recommendation shall be understood in a generic sense; i.e., in the sense that those terms are generally applicable to any of a variety of technologies that provide for the exchange of information between real systems. Those terms are:

- a) confirmation;
- b) indication;
- c) primitive;
- d) request;
- e) response;
- f) service provider;
- g) service user.

1.6.1.3 Terms Defined in this Recommendation

For the purposes of this Recommendation, the following definitions also apply. Many other terms that pertain to specific items are defined in the appropriate sections.

aperiodic: not *periodic* (see below).

asynchronous: not *synchronous* (see below).

delimited: having a known (and finite) length; applies to data in the context of data handling.

Mission Phase: a period of a mission during which specified communications characteristics are fixed. The transition between two consecutive Mission Phases may cause an interruption of the communications services.

periodic: of or pertaining to a sequence of events in which each event occurs at a fixed time interval (within specified tolerance) after the previous event in the sequence.

Physical Channel: a stream of bits transferred over a space link in a single direction.

space link: a communications link between a spacecraft and its associated ground system or between two spacecraft. A space link consists of one or more Physical Channels in one or both directions.

synchronous: of or pertaining to a sequence of events occurring in a fixed time relationship (within specified tolerance) to another sequence of events. Note that 'synchronous' does not necessarily imply 'periodic' or 'constant rate'.

1.6.2 NOMENCLATURE

The following conventions apply throughout this Recommendation:

- a) the words 'shall' and 'must' imply a binding and verifiable specification;
- b) the word 'should' implies an optional, but desirable, specification;
- c) the word 'may' implies an optional specification;
- d) the words 'is', 'are', and 'will' imply statements of fact.

1.6.3 CONVENTIONS

In this document, the following convention is used to identify each bit in an N -bit field. The first bit in the field to be transmitted (i.e., the most left justified when drawing a figure) is defined to be 'Bit 0'; the following bit is defined to be 'Bit 1' and so on up to 'Bit $N-1$ '. When the field is used to express a binary value (such as a counter), the Most Significant Bit (MSB) shall be the first transmitted bit of the field, i.e., 'Bit 0' (see figure 1-1).

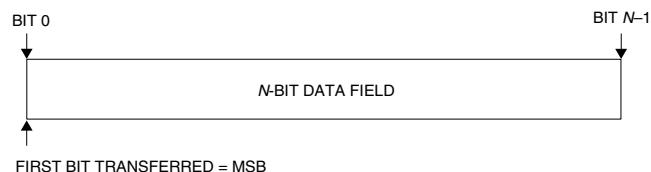

Figure 1-1: Bit Numbering Convention

In accordance with standard data-communications practice, data fields are often grouped into eight-bit ‘words’ which conform to the above convention. Throughout this Recommendation, such an eight-bit word is called an ‘octet’. The numbering for octets within a data structure starts with zero. By CCSDS convention, all ‘spare’ bits shall be permanently set to ‘0’.

1.7 REFERENCES

The following documents contain provisions which, through reference in this text, constitute provisions of this Recommendation. At the time of publication, the editions indicated were valid. All documents are subject to revision, and users of this Recommendation are encouraged to investigate the possibility of applying the most recent editions of the documents indicated below. The CCSDS Secretariat maintains a register of currently valid CCSDS Recommendations.

- [1] *Information Technology—Open Systems Interconnection—Basic Reference Model: The Basic Model*. International Standard, ISO/IEC 7498-1. 2nd ed. Geneva: ISO, 1994.
- [2] *Information Technology—Open Systems Interconnection—Basic Reference Model—Conventions for the Definition of OSI Services*. International Standard, ISO/IEC 10731:1994. Geneva: ISO, 1994.
- [3] *TM Synchronization and Channel Coding*. Recommendation for Space Data System Standards, CCSDS 131.0-B-1. Blue Book. Issue 1. Washington, D.C.: CCSDS, September 2003.
- [4] *Space Link Identifiers*. Recommendation for Space Data System Standards, CCSDS 135.0-B-1. Blue Book. Issue 1. Washington, D.C.: CCSDS, January 2002.
- [5] *CCSDS Global Spacecraft Identification Field Code Assignment Control Procedures*. Recommendation for Space Data System Standards, CCSDS 320.0-B-3. Blue Book. Issue 3. Washington, D.C.: CCSDS, April 2003.
- [6] *Space Packet Protocol*. Recommendation for Space Data System Standards, CCSDS 133.0-B-1. Blue Book. Issue 1. Washington, D.C.: CCSDS, September 2003.

NOTE – Informative references are listed in annex B.

2 OVERVIEW

2.1 CONCEPT OF AOS SPACE DATA LINK PROTOCOL

2.1.1 ARCHITECTURE

The AOS Space Data Link Protocol is a Data Link Layer protocol (see reference [1]) to be used by space missions. This protocol has been designed to meet the requirements of space missions for efficient transfer of space application data of various types and characteristics over space-to-ground, ground-to-space, or space-to-space communications links (hereafter called space links).

Figure 2-1 illustrates the relationship of this protocol to the reference model of Open Systems Interconnection (reference [1]). Two sublayers of the Data Link Layer are defined for CCSDS space link protocols as shown in reference [B3]. The AOS Space Data Link Protocol corresponds to the Data Link Protocol Sublayer, and provides functions of transferring various data using a fixed-length protocol data unit called the Transfer Frame. The Synchronization and Channel Coding Sublayer provides some additional functions necessary for transferring Transfer Frames over a space link. These functions are delimiting/synchronizing Transfer Frames, error-correction coding/decoding (optional), and bit transition generation/removal (optional). For the Synchronization and Channel Coding Sublayer, the TM Synchronization and Channel Coding Recommendation (reference [3]) must be used with the AOS Space Data Link Protocol. How the AOS Space Data Link Protocol is used in overall space data systems is shown in reference [B3].

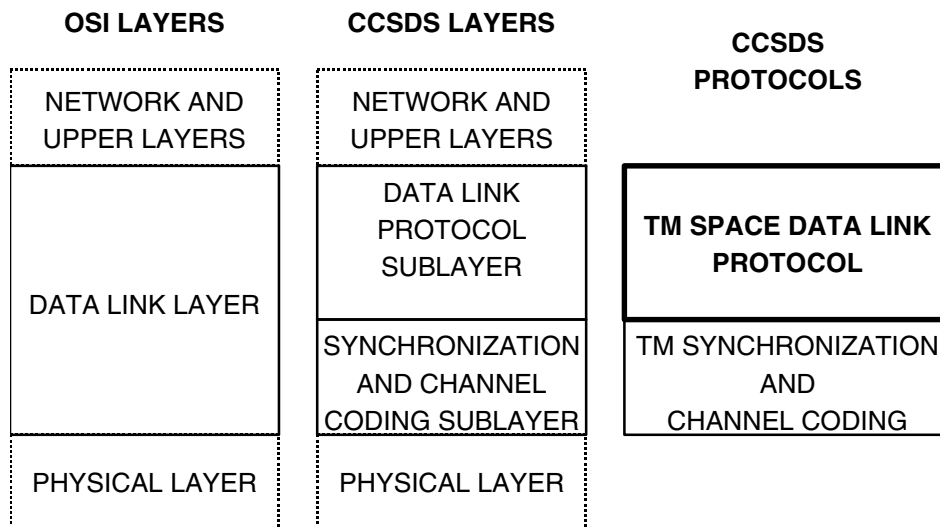

Figure 2-1: Relationship with OSI Layers

2.1.2 PROTOCOL FEATURES

The AOS Space Data Link Protocol provides the users with several services to transfer service data units over a space link. To facilitate simple, reliable, and robust synchronization

procedures, fixed-length protocol data units are used to transfer data through the weak-signal, noisy space links: their length is established for a particular Physical Channel (a single stream of bits transferred over a space link in a single direction) during a particular Mission Phase by management. These protocol data units are known as AOS Transfer Frames (unless otherwise stated, the terms ‘Transfer Frame’ and ‘Frame’ in this document refer to the AOS Transfer Frame). Each Transfer Frame contains a header which provides protocol control information and a fixed-length data field within which higher-layer service data units are carried.

A key feature of the AOS Space Data Link Protocol is the concept of ‘Virtual Channels’ (VC). The Virtual Channel facility allows one Physical Channel to be shared among multiple higher-layer data streams, each of which may have different service requirements. A single Physical Channel may therefore be divided into several separate logical data channels, each known as a ‘Virtual Channel’. Each Transfer Frame transferred over a Physical Channel belongs to one of the Virtual Channels of the Physical Channel.

2.1.3 ADDRESSING

There are three identifier fields in the header of Transfer Frames: Transfer Frame Version Number (TFVN), Spacecraft Identifier (SCID), and Virtual Channel Identifier (VCID). The concatenation of a TFVN and a SCID is known as a Master Channel Identifier (MCID), and the concatenation of an MCID and a VCID is called a Global Virtual Channel Identifier (GVCID). Therefore,

$$\text{MCID} = \text{TFVN} + \text{SCID};$$

$$\text{GVCID} = \text{MCID} + \text{VCID} = \text{TFVN} + \text{SCID} + \text{VCID}.$$

Each Virtual Channel in a Physical Channel is identified by a GVCID. Therefore, a Virtual Channel consists of Transfer Frames with the same GVCID.

All Transfer Frames with the same MCID on a Physical Channel constitute a Master Channel (MC). A Master Channel consists of one or more Virtual Channels. In most cases, a Physical Channel carries only Transfer Frames of a single MCID, and the Master Channel will be identical with the Physical Channel. However, a Physical Channel may carry Transfer Frames with multiple MCIDs (with the same TFVN). In such a case, the Physical Channel consists of multiple Master Channels. A Physical Channel is identified with a Physical Channel Name, which is set by management and not included in the header of Transfer Frames.

The relationships between these Channels are shown in figure 2-2.

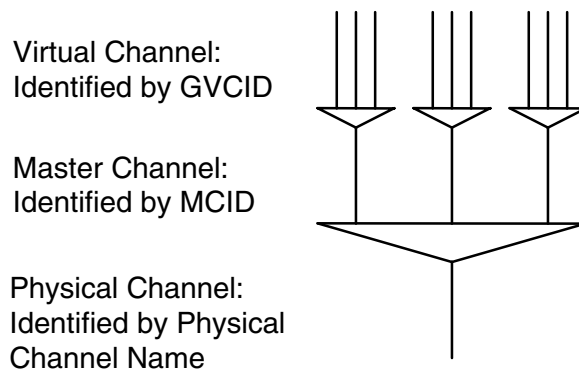

Figure 2-2: Relationships between Channels

2.1.4 PROTOCOL DESCRIPTION

The AOS Space Data Link Protocol is described in terms of:

- a) the services provided to the users;
- b) the protocol data units; and
- c) the procedures performed by the protocol.

The service definitions are given in the form of primitives, which present an abstract model of the logical exchange of data and control information between the protocol entity and the service user. The definitions of primitives are independent of specific implementation approaches.

The procedure specifications define the procedures performed by protocol entities for the transfer of information between peer entities. The definitions of procedures are independent of specific implementation methods or technologies.

This protocol specification also specifies the requirements for the underlying services provided by the Channel Coding Sublayer and the Physical Layer.

2.2 OVERVIEW OF SERVICES

2.2.1 COMMON FEATURES OF SERVICES

The AOS Space Data Link Protocol provides users with data transfer services. The point at which a service is provided by a protocol entity to a user is called a Service Access Point (SAP) (see reference [1]). Each service user is identified by a SAP address.

Service data units submitted to a SAP are processed in the order of submission. No processing order is maintained for service data units submitted to different SAPs.

NOTE – Implementations may be required to perform flow control at an SAP between the service user and the service provider. However, CCSDS does not recommend a scheme for flow control between the user and the provider.

The followings are features common to all the services defined by this Recommendation:

- a) unidirectional (one way) services: one end of a connection can send, but not receive, data through the space link, while the other end can receive, but not send.
- b) unconfirmed services: the sending user does not receive confirmation from the receiving end that data has been received.
- c) incomplete services: the services do not guarantee completeness, but some services may signal gaps in the sequence of service data units delivered to the receiving user.
- d) sequence-preserving services: the sequence of service data units supplied by the sending user is preserved through the transfer over the space link, although there may be gaps and duplications in the sequence of service data units delivered to the receiving user.

NOTE – This Recommendation assumes that these services are provided at the end points of a space link. However, this Recommendation makes no assumptions concerning how these end points are composed or configured either on-board a spacecraft or in a ground system. In a ground system, the services defined by this Recommendation may be extended or enhanced with Space Link Extension Services (reference [B4]).

2.2.2 SERVICE TYPES

2.2.2.1 Overview

The AOS Space Data Link Protocol provides three service types (asynchronous, synchronous, and periodic) that determine how service data units supplied by the user are transferred in protocol data units over a space link.

The models shown below are intended only to illustrate the characteristics of services. They are not intended to guide or restrict design of on-board or ground systems.

2.2.2.2 Asynchronous Service

In asynchronous service, there are no timing relationships between the transfer of service data units supplied by the service user and the transmission of Transfer Frames generated by the service provider. The user may request data transfer at any time it desires, but there may be restrictions imposed by the provider on the data generation rate. In this service (figure 2-3), each service data unit from a sending user is placed in a queue, the contents of which are sent to a receiving user in the order in which they were presented. Although transmission errors may prevent delivery of some data units, the service provider attempts to transfer all

data units provided by the user exactly once. The timing of data transfer is determined by the provider in accordance with mission-specific rules, and may depend on the traffic at the time of transfer. The key feature of this service is that all of the service data units from the sending user are transferred, and transferred only once.

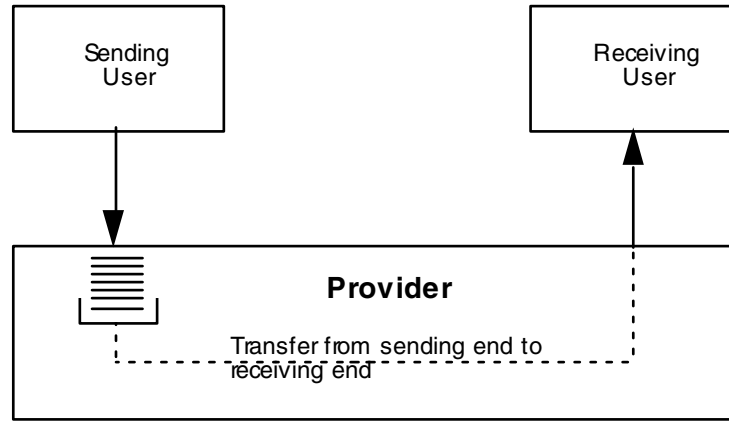

Figure 2-3: Asynchronous Service Model

2.2.2.3 Synchronous Service

In synchronous service, the transfer of service data units is synchronized with the release of either (1) Transfer Frames of a Virtual Channel, (2) Transfer Frames of a Master Channel, or (3) all Transfer Frames of a Physical Channel. The transfer timing may be periodic or aperiodic.

In this service (figure 2-4), each service data unit from a sending user is placed in a buffer that can hold only one service data unit; the content of the buffer is sent to a receiving user at the time when a Transfer Frame is transmitted. The transmission timing of Transfer Frames is determined by the service provider according to mission-specific rules (usually known to the user). The key feature of this service, which is essentially time-division multiplexing, is that the timing of data transfer is driven by the transfer mechanism, not by individual service requests from the user. Thus a particular service data unit from a user might be sent once, several times (if the 'new' value is not placed in the buffer soon enough), or not at all (if one value is replaced by a second before the service provider can send it).

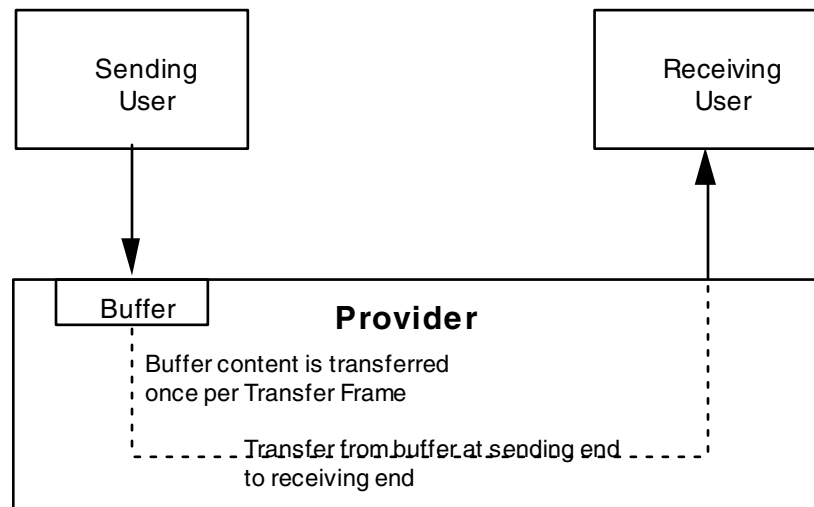

Figure 2-4: Synchronous Service Model

2.2.2.4 Periodic Service

Periodic service is a special case of synchronous service in which service data units are transferred at a constant rate. Periodic transfer from service interface to service interface is provided with a specified maximum delay and a specified maximum jitter at the service interface. There are three cases in which a synchronous service is periodic:

- a) If the service is associated with a Virtual Channel (or a Master Channel) and that Virtual (or Master) Channel produces Transfer Frames at a constant rate, then the service is periodic.
- b) If the service is associated with a Master Channel and there is only one Master Channel in the Physical Channel, then the service is periodic.

For periodic services, all service data units are sent only once if the user supplies service data units at the same rate as the rate at which the service provider transfers them.

2.2.3 SUMMARY OF SERVICES

2.2.3.1 Overview

Seven services are provided by the AOS Space Data Link Protocol. Five of them (Packet, Bitstream, Virtual Channel Access, Virtual Channel Operational Control Field, and Virtual Channel Frame) are provided for a Virtual Channel. One of them (Master Channel Frame) is provided for a Master Channel. One of them (Insert) is provided for all Transfer Frames in a Physical Channel. Table 2-1 summarizes these services.

Table 2-1: Summary of Services Provided by AOS Space Data Link Protocol

| Service | Service Type | Service Data Unit | SAP Address |
|--|--------------------------|--------------------------|-------------------------------|
| Packet | Asynchronous | Packet | GVCID + Packet Version Number |
| Bitstream | Asynchronous or Periodic | Bitstream Data | GVCID |
| Virtual Channel Access (VCA) | Asynchronous or Periodic | VCA_SDU | GVCID |
| Virtual Channel Operational Control Field (VC_OCF) | Synchronous or Periodic | OCF_SDU | GVCID |
| Virtual Channel Frame (VCF) | Asynchronous or Periodic | Transfer Frame | GVCID |
| Master Channel Frame (MCF) | Asynchronous or Periodic | Transfer Frame | MCID |
| Insert | Periodic | IN_SDU | Physical Channel Name |

2.2.3.2 Packet Service

The Packet Service transfers a sequence of variable-length, delimited, octet-aligned service data units known as Packets across a space link. The Packets transferred by this service must have a Packet Version Number (PVN) authorized by CCSDS. For the Packet Version Numbers presently authorized by CCSDS, see reference [4]. The service is unidirectional, asynchronous and sequence-preserving. It does not guarantee completeness, nor does it signal gaps in the sequence of service data units delivered to a receiving user.

A user of this service is a protocol entity that sends or receives Packets with a single PVN. A user is identified with the PVN and a GVCID. Different users (i.e., Packets with different versions) can share a single Virtual Channel, and if there are multiple users on a Virtual Channel, the service provider multiplexes Packets of different versions to form a single stream of Packets to be transferred on that Virtual Channel.

2.2.3.3 Bitstream Service

The Bitstream service provides transfer of a serial string of bits, whose internal structure and boundaries are unknown to the service provider, across a space link. The service is unidirectional, either asynchronous or periodic, and sequence-preserving. The service does not guarantee completeness, but it may signal gaps in the sequence of service data units delivered to the receiving user.

For a given service instance, only one user, identified with the GVCID of the Virtual Channel, can use this service on a Virtual Channel. Bitstreams from different users are not multiplexed together within one Virtual Channel.

2.2.3.4 Virtual Channel Access (VCA) Service

The Virtual Channel Access (VCA) Service provides transfer of a sequence of privately formatted service data units of fixed length across a space link. The service is unidirectional, either asynchronous or periodic, and sequence-preserving. The service does not guarantee completeness, but it may signal gaps in the sequence of service data units delivered to the receiving user.

For a given service instance, only one user, identified with the GVCID of the Virtual Channel, can use this service on a Virtual Channel. Service data units from different users are not multiplexed together within one Virtual Channel.

2.2.3.5 Virtual Channel Operational Control Field (VC_OCF) Service

The Virtual Channel Operational Control Field (VC_OCF) Service provides synchronous transfer of fixed-length data units, each consisting of four octets, in the Operational Control Field (OCF) of Transfer Frames of a Virtual Channel. The service is unidirectional and sequence-preserving. The transfer is synchronized with the release of Transfer Frames of a Virtual Channel. The service does not guarantee completeness, but it may signal gaps in the sequence of service data units delivered to the receiving user.

For a given service instance, only one user, identified with the GVCID of the Virtual Channel, can use this service on a Virtual Channel. Service data units from different users are not multiplexed together within one Virtual Channel.

2.2.3.6 Virtual Channel Frame (VCF) Service

The Virtual Channel Frame (VCF) Service provides transfer of a sequence of fixed-length AOS Transfer Frames of a Virtual Channel, created by an independent protocol entity, across a space link. The service is unidirectional, either asynchronous or periodic, and sequence-preserving. The service does not guarantee completeness, but it may signal gaps in the sequence of service data units delivered to the receiving user.

For a given service instance, only one user, identified with the GVCID of the Virtual Channel, can use this service on a Virtual Channel. Service data units from different users are not multiplexed together within one Virtual Channel.

The Virtual Channel Frame Service transfers the independently created AOS Transfer Frames through a space link, together with AOS Transfer Frames created by the service provider itself. This service is made available to trusted users who are certified during the design process to ensure that the independently created protocol data units do not violate the operational integrity of the space link. Necessarily, the independent Transfer Frames must have the same length as those generated by the service provider.

2.2.3.7 Master Channel Frame (MCF) Service

The Master Channel Frame (MCF) Service provides transfer of a sequence of fixed-length AOS Transfer Frames of a Master Channel, created by an independent protocol entity, across a space link. The service is unidirectional, either asynchronous or periodic, and sequence-preserving. The service does not guarantee completeness, but it may signal gaps in the sequence of service data units delivered to a receiving user.

For a given service instance, only one user, identified with the MCID of the Master Channel, can use this service on a Master Channel. Service data units from different users are not multiplexed together within one Master Channel.

The Master Channel Frame Service transfers the independently created AOS Transfer Frames through the space link, together with AOS Transfer Frames created by the service provider itself. This service is made available to trusted users who are certified during the design process to ensure that the independently created protocol data units do not violate the operational integrity of the space link. Necessarily, the independent Transfer Frames must have the same length as those generated by the service provider.

2.2.3.8 Insert Service

The Insert Service provides transfer of private, fixed-length, octet-aligned service data units across a space link in a mode which efficiently utilizes the space link transmission resources at relatively low data rates. The service is unidirectional, periodic, and sequence-preserving. The service does not guarantee completeness, but may signal gaps in the sequence of service data units delivered to a receiving user.

For a given service instance, only one user, identified with the Physical Channel Name of the Physical Channel, can use this service on a Physical Channel. Service data units from different users are not multiplexed together within one Physical Channel.

2.2.4 RESTRICTIONS ON SERVICES

There are some restrictions on the services provided on a Physical Channel, as follows:

- a) On one Physical Channel, the Insert service shall not exist simultaneously with the Virtual Channel Frame or Master Channel Frame service.
- b) If the Master Channel Frame Service exists on a Master Channel, other services shall not exist simultaneously on that Master Channel.
- c) If the Virtual Channel Frame Service exists on a Virtual Channel, other services shall not exist simultaneously on that Virtual Channel.
- d) On a Virtual Channel on which the Virtual Channel Frame Service does not exist, only one of the Packet Service, the Bitstream Service, or the Virtual Channel Access Service shall exist simultaneously.

2.3 OVERVIEW OF FUNCTIONS

2.3.1 GENERAL FUNCTIONS

The AOS Space Data Link Protocol transfers various service data units supplied by sending users encapsulated in a sequence of protocol data units using services of lower layers. The protocol data units, known as AOS Transfer Frames, have a fixed length and must be transferred over a Physical Channel at a constant rate.

The protocol entity performs the following protocol functions:

- a) generation and processing of protocol control information (i.e., headers and trailers) to perform data identification, loss detection, and error detection;
- b) segmenting and blocking of service data units to transfer variable-length service data units in fixed-length protocol data units;
- c) multiplexing/demultiplexing and commutation/decommutation in order for various service users to share a single Physical Channel;
- d) generation and removal of idle data to transfer protocol data units at a constant rate.

The protocol entity does not perform the following protocol functions:

- a) connection establishment and release;
- b) flow control;
- c) retransmission of protocol data units.

2.3.2 INTERNAL ORGANIZATION OF PROTOCOL ENTITY

Figures 2-5 and 2-6 show the internal organization of the protocol entity of the sending and receiving ends, respectively. Data flow from top to bottom in figure 2-5 and from bottom to top in figure 2-6. These figures identify data-handling functions performed by the protocol entity and show logical relationships among these functions. The figures are not intended to

imply any hardware or software configuration in a real system. Depending on the services actually used for a real system, not all of the functions may be present in the protocol entity.

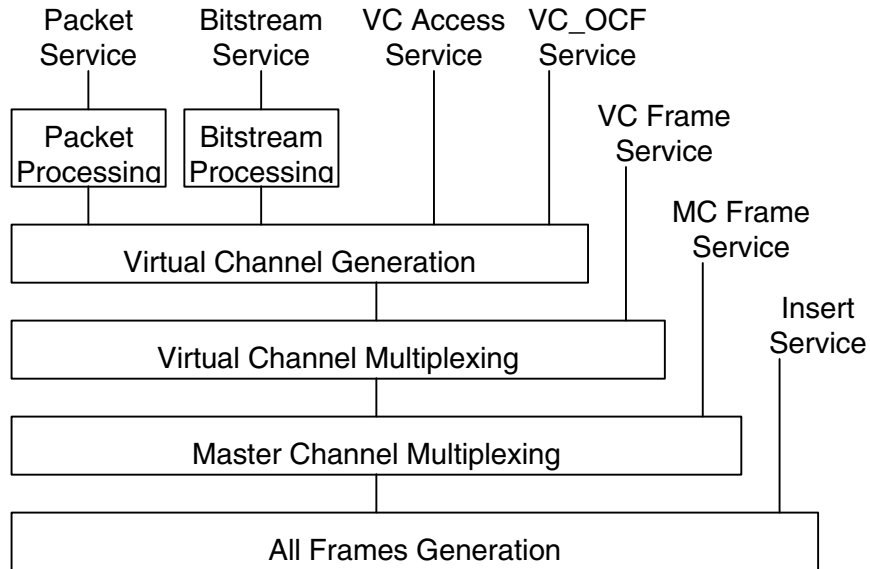

Figure 2-5: Internal Organization of Protocol Entity (Sending End)

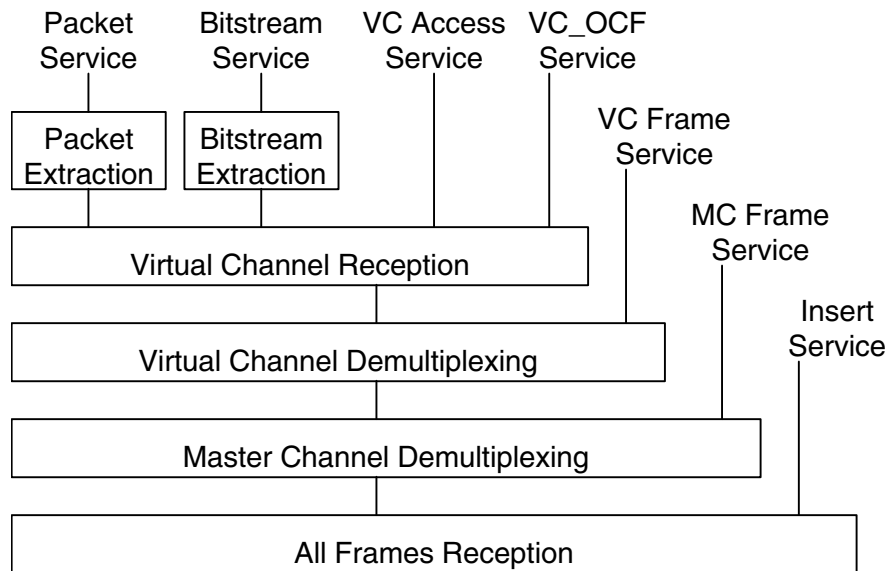

Figure 2-6: Internal Organization of Protocol Entity (Receiving End)

By extracting multiplexing/demultiplexing and commutation/decommutation functions from figures 2-5 and 2-6, the relationship among various data units can be shown as figure 2-7, which is known as the Channel Tree of the AOS Space Data Link Protocol.

In figure 2-7, multiplexing (shown with a triangle) is a function of mixing, according to an algorithm established by the project, multiple streams of data units, each with a different identifier, to generate a single stream of data units. Commutation (shown with a box) is a function of concatenating, according to the formatting rule specified by the protocol definition, multiple data units, each from a different service, in a single protocol data unit sharing the same identifier.

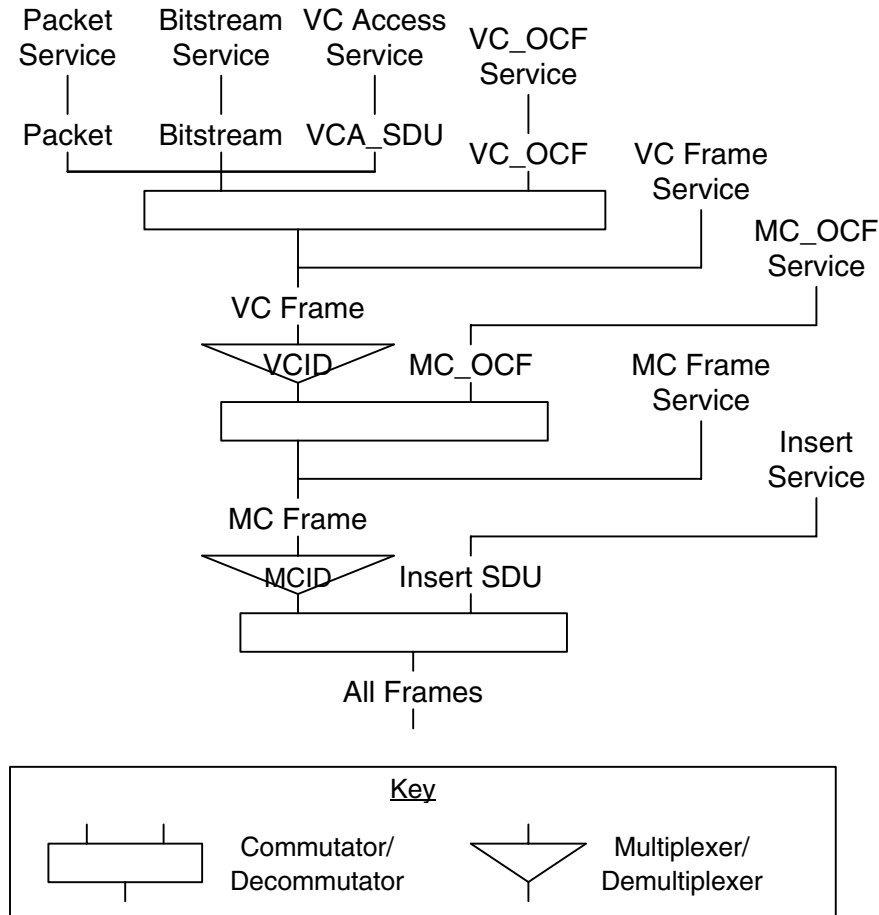

Figure 2-7: AOS Space Data Link Protocol Channel Tree

2.4 SERVICES ASSUMED FROM LOWER LAYERS

2.4.1 SERVICES ASSUMED FROM THE SYNCHRONIZATION AND CHANNEL CODING SUBLAYER

As described in 2.1.1, the TM Channel Coding and Synchronization Recommendation (reference [3]) must be used with the AOS Space Data Link Protocol as the TM Synchronization and Channel Coding Sublayer specification. The functions provided by the Synchronizat on and Channel Coding Recommendation are:

- a) error control encoding and decoding functions (optional);

- b) bit transition generation and removal functions (optional);
- c) delimiting and synchronizing functions.

The TM Synchronization and Channel Coding Sublayer, then, transfers contiguous, fixed-length, delimited protocol data units as a contiguous stream of bits over a space link using the services of the underlying Physical Layer.

2.4.2 PERFORMANCE REQUIREMENTS TO LOWER LAYERS

The coding options of the Channel Coding and Synchronization Recommendation and the performance of the RF link provided by the Physical Layer shall be chosen according to the following criteria:

- a) The probability of misidentifying the MCID and VCID shall be less than a mission-specified value.
- b) The probability of not correctly extracting Packets from Transfer Frames using the First Header Pointer and the Packet Length Field shall be less than a mission-specified value.

In order to assure correct decoding at the receiving end, the same coding options must be applied to all Transfer Frames of a Physical Channel.

3 SERVICE DEFINITION

3.1 OVERVIEW

This section provides service definition in the form of primitives, which present an abstract model of the logical exchange of data and control information between the protocol entity and the service user. The definitions of primitives are independent of specific implementation approaches.

The parameters of the primitives are specified in an abstract sense and specify the information to be made available to the user of the primitives. The way in which a specific implementation makes this information available is not constrained by this specification. In addition to the parameters specified in this section, an implementation may provide other parameters to the service user (e.g., parameters for controlling the service, monitoring performance, facilitating diagnosis, and so on).

3.2 SOURCE DATA

3.2.1 SOURCE DATA OVERVIEW

NOTE – This subsection describes the service data units that are transferred from sending users to receiving users by the AOS Space Data Link Protocol.

The service data units transferred by the AOS Space Data Link Protocol shall be:

- a) Packet;
- b) Bitstream Data;
- c) Virtual Channel Access Service Data Unit (VCA_SDU);
- d) Operational Control Field Service Data Unit (OCF_SDU);
- e) AOS Transfer Frame;
- f) Insert Service Data Unit (IN_SDU).

3.2.2 PACKET

3.2.2.1 Packets shall be transferred over a space link with the Packet Service.

3.2.2.2 The Packets transferred by this service must have a Packet Version Number (PVN) authorized by CCSDS.

3.2.2.3 The position and length of the Packet Length Field of the Packets must be known to the service provider in order to extract Packets from Transfer Frames at the receiving end.

NOTES

- 1 Packets are variable-length, delimited, octet-aligned data units, and are usually the protocol data unit of a Network Layer protocol.
- 2 For the Packet Version Numbers presently authorized by CCSDS, see reference [4]. Further, each Packet transferred shall conform to the corresponding packet format specified by reference [4].

3.2.3 BITSTREAM DATA

Bitstream Data shall be transferred over a space link with the Bitstream Service. The length of the Bitstream Data supplied in each Bitstream service request may not be preserved through transfer, since the Bitstream Data supplied in a service request may be segmented into multiple Transfer Frames or blocked in a Transfer Frame with the data supplied in other service requests.

NOTE – Bitstream Data are variable-length, undelimited strings of bits, the format of which is unknown to the service provider.

3.2.4 VIRTUAL CHANNEL ACCESS SERVICE DATA UNIT (VCA_SDU)

VCA_SDUs shall be transferred over a space link with the Virtual Channel Access Service.

NOTE – Virtual Channel Access Service Data Units (VCA_SDUs) are fixed-length, octet-aligned data units, the format of which is unknown to the service provider. Their length is established by management.

3.2.5 OPERATIONAL CONTROL FIELD SERVICE DATA UNIT (OCF_SDU)

3.2.5.1 Operational Control Field Service Data Units (OCF_SDUs) shall be transferred over a space link with the VC_OCF Service. Data units shall be carried in every Transfer Frame of a Virtual Channel.

3.2.5.2 Although the transfer of OCF_SDUs is synchronized with the Virtual Channel that shall provide the transfer service, the creation of OCF_SDUs by the sending user may or may not be synchronized with the Virtual Channel. Such synchronization, if required for timing or other purposes, is a mission-design issue.

NOTES

- 1 OCF_SDUs are fixed-length data units, each consisting of four octets, carried in the Operational Control Field (OCF), defined in 4.1.5, from a sending end to a receiving end.

- 2 As defined in 4.1.5, CCSDS specifies the use of the first bit of this field to indicate the type of data carried.

3.2.6 AOS TRANSFER FRAME

NOTE – The AOS Transfer Frame is the fixed-length protocol data unit of the AOS Space Data Link Protocol, but also can be used as the service data units of the Virtual Channel Frame and Master Channel Frame Services. Its format is defined in 4.1 of this Recommendation. The length of any Transfer Frame transferred on a Physical Channel must be the same, and is established by management.

3.2.7 INSERT SERVICE DATA UNIT (IN_SDU)

NOTE – Insert Service Data Units (IN_SDUs) are periodic, octet-aligned data units of fixed length. Their length may be of any constant value which is an integral number of octets, between 1 octet and the maximum length of the data-carrying space of the Transfer Frames, and is established by management. The length of IN_SDUs at the sending interface is always equal to the length at the receiving interface.

3.3 PACKET SERVICE

3.3.1 OVERVIEW OF PACKET SERVICE

The Packet Service transfers a sequence of variable-length, delimited, octet-aligned service data units known as Packets across a space link. The Packets transferred by this service must have a Packet Version Number (PVN) authorized by CCSDS. For the Packet Version Numbers presently authorized by CCSDS, see reference [4]. The service is unidirectional, asynchronous and sequence-preserving. It does not guarantee completeness, nor does it signal gaps in the sequence of service data units delivered to a receiving user.

A user of this service is a protocol entity that sends or receives Packets with a single PVN, and identified with the PVN and a GVCID. Different users (i.e., Packets with different versions) can share a single Virtual Channel, and if there are multiple users on a Virtual Channel, the service provider multiplexes Packets of different versions to form a single stream of Packets to be transferred on that Virtual Channel.

3.3.2 PACKET SERVICE PARAMETERS

3.3.2.1 General

The parameters used by the Packet Service primitives shall conform to the specifications contained in subsections 3.3.2.2 through 3.3.2.5.

3.3.2.2 Packet

The Packet parameter shall contain a Packet for transfer by the Packet Service.

NOTE – The Packet parameter is the service data unit transferred by the Packet Service.
For restrictions on the Packets transferred by the Packet Service, see 3.2.2.

3.3.2.3 GVCID

The GVCID parameter shall contain a GVCID that indicates the Virtual Channel through which the Packet is to be transferred.

NOTE – The GVCID is part of the SAP address of the Packet Service.

3.3.2.4 Packet Version Number

The PVN shall identify the protocol entity of the upper layer that uses the Packet Service.

NOTE – The PVN is part of the SAP address of the Packet Service.

3.3.2.5 Packet Quality Indicator

The Packet Quality Indicator is an optional parameter that may be used to notify the user at the receiving end of the Packet Service whether the Packet delivered by the primitive is complete or partial.

3.3.3 PACKET SERVICE PRIMITIVES

3.3.3.1 General

The service primitives associated with this service are:

- a) PACKET.request;
- b) PACKET.indication.

3.3.3.2 PACKET.request

3.3.3.2.1 Function

At the sending end, the Packet Service user shall pass a PACKET.request primitive to the service provider to request that a Packet be transferred to the user at the receiving end through the specified Virtual Channel.

NOTE – The PACKET.request primitive is the service request primitive for the Packet Service.

3.3.3.2.2 Semantics

The PACKET.request primitive shall provide parameters as follows:

| | |
|----------------|--|
| PACKET.request | (Packet, GVCID, Packet Version Number) |
|----------------|--|

3.3.3.2.3 When Generated

The PACKET.request primitive shall be passed to the service provider to request it to send the Packet.

3.3.3.2.4 Effect On Receipt

Receipt of the PACKET.request primitive shall cause the service provider to transfer the Packet.

3.3.3.2.5 Additional Comments

The PACKET.request primitive shall be used to transfer Packets across the space link on the specified Virtual Channel.

3.3.3.3 PACKET.indication

3.3.3.3.1 Function

At the sending end, the service provider shall pass a PACKET.indication to the Packet Service user at the receiving end to deliver a Packet.

NOTE – The PACKET.indication primitive is the service indication primitive for the Packet Service.

3.3.3.3.2 Semantics

The PACKET.indication primitive shall provide parameters as follows:

| | |
|-------------------|--------------------|
| PACKET.indication | (Packet, GVCID, |
|-------------------|--------------------|

Packet Version Number,
Packet Quality Indicator (optional))

3.3.3.3.3 When Generated

The PACKET.indication primitive shall be passed from the service provider to the Packet Service user at the receiving end to deliver a Packet.

3.3.3.3.4 Effect On Receipt

The effect of receipt of the PACKET.indication primitive by the Packet Service user is undefined.

3.3.3.3.5 Additional Comments

The PACKET.indication primitive shall be used to deliver Packets to the Packet Service user identified by the GVCID and Packet Version Number. Incomplete Packets may be delivered (optional).

3.4 BITSTREAM SERVICE

3.4.1 OVERVIEW OF BITSTREAM SERVICE

The Bitstream Service provides transfer of a serial string of bits, whose internal structure and boundaries are unknown to the service provider, across a space link. The service is unidirectional, either asynchronous or periodic, and sequence-preserving. The service does not guarantee completeness, but may signal gaps in the sequence of service data units delivered to the receiving user.

Only one user can use this service on a Virtual Channel, and the user is identified with the GVCID of the Virtual Channel. Bitstreams from different users are not multiplexed together within one Virtual Channel.

3.4.2 BITSTREAM SERVICE PARAMETERS

3.4.2.1 General

The parameters used by the Bitstream Service primitives shall conform to the specifications contained in subsections 3.4.2.2 through 3.4.2.4.

3.4.2.2 Bitstream Data

The parameter Bitstream Data shall be the service data unit transferred by the Bitstream Service.

NOTE – For restrictions on the Bitstream Data transferred by the Bitstream Service, see 3.2.3.

3.4.2.3 GVCID

The GVCID parameter shall contain a GVCID that indicates the Virtual Channel through which the Bitstream Data is to be transferred.

NOTE – The GVCID is the SAP address of the Bitstream Service.

3.4.2.4 Bitstream Data Loss Flag

The Bitstream Data Loss Flag is an optional parameter that may be used to notify the user at the receiving end of the Bitstream Service that a sequence discontinuity has been detected and that some Bitstream Data may have been lost. If implemented, the flag shall be derived by examining the Virtual Channel Frame Count in the Transfer Frames.

NOTE – As the contents (valid Bitstream Data or idle data) of lost Transfer Frames cannot be established, the user should be aware that the Bitstream Data Loss Flag signals a disruption in the Transfer Frames of the specified Virtual Channel, and not necessarily a disruption of the Bitstream Data itself.

3.4.3 BITSTREAM SERVICE PRIMITIVES

3.4.3.1 General

The service primitives associated with this service are:

- a) BITSTREAM.request;
- b) BITSTREAM.indication.

3.4.3.2 BITSTREAM.request

3.4.3.2.1 Function

At the sending end, the Bitstream Service user shall pass a BITSTREAM.request primitive to the service provider to request that Bitstream Data be transferred to the user at the receiving end through the specified Virtual Channel.

NOTE – The BITSTREAM.request primitive is the service request primitive for the Bitstream Service.

3.4.3.2.2 Semantics

The BITSTREAM.request primitive shall provide parameters as follows:

| | |
|-------------------|----------------------------|
| BITSTREAM.request | (Bitstream Data, GVCID) |
|-------------------|----------------------------|

3.4.3.2.3 When Generated

The BITSTREAM.request primitive shall be passed to the service provider to request it to send the Bitstream Data.

3.4.3.2.4 Effect On Receipt

Receipt of the BITSTREAM.request primitive shall cause the service provider to transfer the Bitstream Data.

3.4.3.2.5 Additional Comments

The BITSTREAM.request primitive shall be used to transfer Bitstream Data across the space link on the specified Virtual Channel.

NOTE – Since the service interface specification is an abstract specification, the implementation of the Bitstream Data parameter is not constrained; i.e., it may be continuous Bitstream, delimited Bitstream, or individual bits.

3.4.3.3 BITSTREAM.indication

3.4.3.3.1 Function

At the sending end, the service provider shall pass a BITSTREAM.indication to the BITSTREAM Service user at the receiving end to deliver Bitstream Data.

NOTE – The BITSTREAM.indication primitive is the service indication primitive for the Bitstream Service.

3.4.3.3.2 Semantics

The BITSTREAM.indication primitive shall provide parameters as follows:

BITSTREAM.indication (Bitstream Data,
GVCID,
Bitstream Data Loss Flag (optional))

3.4.3.3.3 When Generated

The BITSTREAM.indication primitive shall be passed from the service provider to the Bitstream Service user at the receiving end to deliver Bitstream Data.

3.4.3.3.4 Effect On Receipt

The effect of receipt of the BITSTREAM.indication primitive by the Bitstream Service user is undefined.

3.4.3.3.5 Additional Comments

The BITSTREAM.indication primitive shall be used to deliver Bitstream Data to the Bitstream Service user identified by the GVCID.

NOTE – The quantity of Bitstream Data delivered by an implementation of this service primitive is not defined. Therefore, it is not necessarily related to the quantity of Bitstream Data submitted to the service provider by the sending user with the BITSTREAM.request primitive.

3.5 VIRTUAL CHANNEL ACCESS (VCA) SERVICE

3.5.1 OVERVIEW OF VCA SERVICE

The Virtual Channel Access (VCA) Service provides transfer of a sequence of privately formatted service data units of fixed length across a space link. The service is unidirectional, either asynchronous or periodic, and sequence-preserving. The service does not guarantee completeness, but may signal gaps in the sequence of service data units delivered to the receiving user.

Only one user can use this service on a Virtual Channel and the user is identified with the GVCID of the Virtual Channel. Service data units from different users are not multiplexed together within one Virtual Channel.

3.5.2 VCA SERVICE PARAMETERS

3.5.2.1 General

The parameters used by the VCA Service primitives shall conform to the specifications contained in subsections 3.5.2.2 through 3.5.2.4.

3.5.2.2 VCA_SDU

The parameter VCA_SDU shall be the service data unit transferred by the VCA Service.

NOTE – For restrictions on the VCA_SDUs transferred by the VCA Service, see 3.2.4.

3.5.2.3 GVCID

The GVCID parameter shall contain a GVCID that indicates the Virtual Channel through which the VCA_SDU is to be transferred.

NOTE – The GVCID is the SAP address of the VCA Service.

3.5.2.4 VCA_SDU Loss Flag

The VCA_SDU Loss Flag is an optional parameter that may be used to notify the user at the receiving end of the VCA Service that a sequence discontinuity has been detected, and that one or more VCA_SDUs have been lost. If implemented, the flag shall be derived by examining the Virtual Channel Frame Count in the Transfer Frames.

3.5.3 VCA SERVICE PRIMITIVES

3.5.3.1 General

The service primitives associated with this service are:

- a) VCA.request;
- b) VCA.indication.

3.5.3.2 VCA.request

3.5.3.2.1 Function

At the sending end, the VCA Service user shall pass a VCA.request primitive to the service provider to request that a VCA_SDU be transferred to the user at the receiving end through the specified Virtual Channel.

NOTE – The VCA.request primitive is the service request primitive for the VCA Service.

3.5.3.2.2 Semantics

The VCA.request primitive shall provide parameters as follows:

VCA.request (VCA_SDU,
GVCID)

3.5.3.2.3 When Generated

The VCA.request primitive shall be passed to the service provider to request it to send the VCA_SDU.

3.5.3.2.4 Effect On Receipt

Receipt of the VCA.request primitive shall cause the service provider to transfer the VCA_SDU.

3.5.3.2.5 Additional Comments

The VCA.request primitive shall be used to transfer VCA_SDUs across the space link on the specified Virtual Channel.

3.5.3.3 VCA.indication

3.5.3.3.1 Function

At the sending end, the service provider shall pass a VCA.indication to the VCA Service user at the receiving end to deliver a VCA_SDU.

NOTE – The VCA.indication primitive is the service indication primitive for the VCA Service.

3.5.3.3.2 Semantics

The VCA.indication primitive shall provide parameters as follows:

VCA.indication (VCA_SDU,
GVCID,
VCA_SDU Loss Flag (optional))

3.5.3.3.3 When Generated

The VCA.indication primitive shall be passed from the service provider to the VCA Service user at the receiving end to deliver a VCA_SDU.

3.5.3.3.4 Effect On Receipt

The effect of receipt of the VCA.indication primitive by the VCA Service user is undefined.

3.5.3.3.5 Additional Comments

The VCA.indication primitive shall be used to deliver VCA_SDU to the VCA Service user identified by the GVCID.

3.6 VIRTUAL CHANNEL OPERATIONAL CONTROL FIELD (VC_OCF) SERVICE

3.6.1 OVERVIEW OF VC_OCF SERVICE

The Virtual Channel Operational Control Field (VC_OCF) Service provides synchronous transfer of fixed-length data units, each consisting of four octets, in the Operational Control Field (OCF) of Transfer Frames of a Virtual Channel. The service is unidirectional and sequence-preserving. The transfer is synchronized with the release of Transfer Frames of a Virtual Channel. The service does not guarantee completeness, but it may signal gaps in the sequence of service data units delivered to the receiving user.

Only one user can use this service on a Virtual Channel, and the user is identified with the GVCID of the Virtual Channel. Service data units from different users are not multiplexed together within one Virtual Channel.

3.6.2 VC_OCF SERVICE PARAMETERS

3.6.2.1 General

The parameters used by the VC_OCF Service primitives shall conform to the specifications contained in subsections 3.6.2.2 through 3.6.2.4.

3.6.2.2 OCF_SDU

The parameter OCF_SDU shall be the service data unit transferred by the VC_OCF Service in the Operational Control Field of Transfer Frames of a Virtual Channel.

NOTE – For restrictions on the OCF_SDU transferred by the VC_OCF Service, see 3.2.5.

3.6.2.3 GVCID

The GVCID parameter shall contain a GVCID that indicates the Virtual Channel through which the OCF_SDU is to be transferred.

NOTE – The GVCID is the SAP address of the VC_OCF Service.

3.6.2.4 OCF_SDU Loss Flag

The OCF_SDU Loss Flag is an optional parameter that may be used to notify the user at the receiving end of the VC_OCF Service that a sequence discontinuity has been detected and that one or more OCF_SDUs may have been lost. If implemented, the flag shall be derived by examining the Virtual Channel Frame Count in the Transfer Frames.

3.6.3 VC_OCF SERVICE PRIMITIVES

3.6.3.1 General

The service primitives associated with this service are:

- a) VC_OCF.request;
- b) VC_OCF.indication.

3.6.3.2 VC_OCF.request

3.6.3.2.1 Function

At the sending end, the VC_OCF Service user shall pass a VC_OCF.request primitive to the service provider to request that an OCF_SDU be transferred to the user at the receiving end through the specified Virtual Channel.

NOTE – The VC_OCF.request primitive is the service request primitive for the VC_OCF Service.

3.6.3.2.2 Semantics

The VC_OCF.request primitive shall provide parameters as follows:

| | |
|----------------|---------------------|
| VC_OCF.request | (OCF_SDU, GVCID) |
|----------------|---------------------|

3.6.3.2.3 When Generated

The VC_OCF.request primitive shall be passed to the service provider to request it to send the OCF_SDU.

3.6.3.2.4 Effect On Receipt

Receipt of the VC_OCF.request primitive shall cause the service provider to transfer the OCF_SDU.

3.6.3.2.5 Additional Comments

The VC_OCF.request primitive shall be used to transfer OCF_SDUs across the space link on the specified Virtual Channel.

3.6.3.3 VC_OCF.indication**3.6.3.3.1 Function**

At the sending end, the service provider shall pass a VC_OCF.indication to the VC_OCF Service user at the receiving end to deliver an OCF_SDU.

NOTE – The VC_OCF.indication primitive is the service indication primitive for the VC_OCF Service.

3.6.3.3.2 Semantics

The VC_OCF.indication primitive shall provide parameters as follows:

| | |
|-------------------|--|
| VC_OCF.indication | (OCF_SDU, GVCID, OCF_SDU Loss Flag (optional)) |
|-------------------|--|

3.6.3.3.3 When Generated

The VC_OCF.indication primitive shall be passed from the service provider to the VC_OCF Service user at the receiving end to deliver an OCF_SDU.

3.6.3.3.4 Effect On Receipt

The effect of receipt of the VC_OCF.indication primitive by the VC_OCF Service user is undefined.

3.6.3.3.5 Additional Comments

The VC_OCF.indication primitive shall be used to deliver OCF_SDUs to the VC_OCF Service user identified by the GVCID.

3.7 VIRTUAL CHANNEL FRAME (VCF) SERVICE

3.7.1 OVERVIEW OF VCF SERVICE

The Virtual Channel Frame (VCF) Service provides transfer of a sequence of fixed-length AOS Transfer Frames of a Virtual Channel, created by an independent protocol entity, across a space link. The service is unidirectional, either asynchronous or periodic, and sequence-preserving. The service does not guarantee completeness, but it may signal gaps in the sequence of service data units delivered to the receiving user.

Only one user can use this service on a Virtual Channel, and the user is identified with the GVCID of the Virtual Channel. Service data units from different users are not multiplexed together within one Virtual Channel.

3.7.2 VCF SERVICE PARAMETERS

3.7.2.1 General

The parameters used by the VCF Service primitives shall conform to the specifications contained in subsections 3.7.2.2 through 3.7.2.4.

3.7.2.2 Frame

The Frame parameter shall be an AOS Transfer Frame of the Virtual Channel specified by the GVCID parameter.

NOTES

- 1 The parameter Frame is the service data unit transferred by the VCF Service.
- 2 The format of the GVCID parameter is defined in 4.1.
- 3 For restrictions on the AOS Transfer Frames transferred by the VCF Service, see 3.2.6.

3.7.2.3 GVCID

The GVCID parameter shall contain a GVCID that indicates the Virtual Channel through which the Frame is to be transferred.

NOTE – The GVCID is the SAP address of the VCF Service.

3.7.2.4 Frame Loss Flag

The Frame Loss Flag is an optional parameter that may be used to notify the user at the receiving end of the VCF Service that a sequence discontinuity has been detected and that one or more Transfer Frames of the specified Virtual Channel have been lost. If implemented, the flag shall be derived by examining the Virtual Channel Frame Count in the Transfer Frames.

3.7.3 VCF SERVICE PRIMITIVES

3.7.3.1 General

The service primitives associated with this service are:

- a) VCF.request;
- b) VCF.indication.

3.7.3.2 VCF.request

3.7.3.2.1 Function

At the sending end, the VCF Service user shall pass a VCF.request primitive to the service provider to request that a Frame be transferred to the user at the receiving end through the specified Virtual Channel.

NOTE – The VCF.request primitive is the service request primitive for the VCF Service.

3.7.3.2.2 Semantics

The VCF.request primitive shall provide parameters as follows:

| | |
|-------------|-------------------|
| VCF.request | (Frame, GVCID) |
|-------------|-------------------|

3.7.3.2.3 When Generated

The VCF.request primitive shall be passed to the service provider to request it to send the Frame.

3.7.3.2.4 Effect On Receipt

Receipt of the VCF.request primitive causes the service provider to transfer the Frame.

3.7.3.2.5 Additional Comments

The VCF.request primitive is used to transfer Transfer Frames of a Virtual Channel across the space link.

3.7.3.3 VCF.indication

3.7.3.3.1 Function

At the sending end, the service provider shall pass a VCF.indication to the VCF Service user at the receiving end to deliver a frame.

NOTE – The VCF.indication primitive is the service indication primitive for the VCF Service.

3.7.3.3.2 Semantics

The VCF.indication primitive shall provide parameters as follows:

| | |
|----------------|--|
| VCF.indication | (Frame, GVCID, Frame Loss Flag (optional)) |
|----------------|--|

3.7.3.3.3 When Generated

The VCF.indication primitive is passed from the service provider to the VCF Service user at the receiving end to deliver a Frame.

3.7.3.3.4 Effect On Receipt

The effect of receipt of the VCF.indication primitive by the VCF Service user is undefined.

3.7.3.3.5 Additional Comments

The VCF.indication primitive is used to deliver Transfer Frames of a Virtual Channel to the VCF Service user identified by the GVCID.

3.8 MASTER CHANNEL FRAME (MCF) SERVICE

3.8.1 OVERVIEW OF MCF SERVICE

The Master Channel Frame (MCF) Service provides transfer of a sequence of fixed-length AOS Transfer Frames of a Master Channel, created by an independent protocol entity, across a space link. The service is unidirectional, either asynchronous or periodic, and sequence-preserving. The service does not guarantee completeness, but it may signal gaps in the sequence of service data units delivered to a receiving user.

Only one user can use this service on a Master Channel, and the user is identified with the MCID of the Master Channel. Service data units from different users are not multiplexed together within one Master Channel.

3.8.2 MCF SERVICE PARAMETERS

3.8.2.1 General

The parameters used by the MCF Service primitives shall conform to the specifications contained in subsections 3.8.2.2 through 3.8.2.4.

3.8.2.2 Frame

The Frame parameter shall be an AOS Transfer Frame of the Master Channel specified by the MCID parameter.

NOTES

- 1 The parameter Frame is the service data unit transferred by the VCF Service.
- 2 The format of the MCID parameter is defined in 4.1.
- 3 For restrictions on the AOS Transfer Frames transferred by the MCF Service, see 3.2.6.

3.8.2.3 MCID

The MCID parameter shall contain the MCID of the Master Channel on which the Frame is to be transferred.

NOTE – The MCID is the SAP address of the MCF Service.

3.8.2.4 Frame Loss Flag

The Frame Loss Flag is an optional parameter that may be used to notify the user at the receiving end of the MCF Service that a sequence discontinuity has been detected and that

one or more Transfer Frames of the specified Master Channel may have been lost. If implemented, the flag shall be derived by a signal given by the underlying Channel Coding Sublayer.

3.8.3 MCF SERVICE PRIMITIVES

3.8.3.1 General

The service primitives associated with this service are:

- a) MCF.request;
- b) MCF.indication.

3.8.3.2 MCF.request

3.8.3.2.1 Function

At the sending end, the MCF Service user shall pass an MCF.request primitive to the service provider to request that a Frame be transferred to the user at the receiving end through the specified Master Channel.

NOTE – The MCF.request primitive is the service request primitive for the MCF Service.

3.8.3.2.2 Semantics

The MCF.request primitive shall provide parameters as follows:

| | |
|-------------|------------------|
| MCF.request | (Frame, MCID) |
|-------------|------------------|

3.8.3.2.3 When Generated

The MCF.request primitive shall be passed to the service provider to request it to send the Frame.

3.8.3.2.4 Effect On Receipt

Receipt of the MCF.request primitive shall cause the service provider to transfer the Frame.

3.8.3.2.5 Additional Comments

The MCF.request primitive shall be used to transfer Transfer Frames of a Master Channel across the space link.

3.8.3.3 MCF.indication**3.8.3.3.1 Function**

At the sending end, the service provider shall pass an MCF.indication to the MCF Service user at the receiving end to deliver a Frame.

NOTE – The MCF.indication primitive is the service indication primitive for the MCF Service.

3.8.3.3.2 Semantics

The MCF.indication primitive shall provide parameters as follows:

| | |
|----------------|---|
| MCF.indication | (Frame, MCID, Frame Loss Flag (optional)) |
|----------------|---|

3.8.3.3.3 When Generated

The MCF.indication primitive shall be passed from the service provider to the MCF Service user at the receiving end to deliver a Frame.

3.8.3.3.4 Effect On Receipt

The effect of receipt of the MCF.indication primitive by the MCF Service user is undefined.

3.8.3.3.5 Additional Comments

The MCF.indication primitive shall be used to deliver Transfer Frames of a Master Channel to the VCF Service user identified by the MCID.

3.9 INSERT SERVICE**3.9.1 OVERVIEW OF INSERT SERVICE**

The Insert Service provides transfer of private, fixed-length, octet-aligned service data units across a space link in a mode which efficiently utilizes the space link transmission resources at relatively low data rates. The service is unidirectional, periodic, and sequence-preserving. The service does not guarantee completeness, but may signal gaps in the sequence of service data units delivered to a receiving user.

Only one user can use this service on a Physical Channel and the user is identified with the Physical Channel Name of the Physical Channel. Service data units from different users are not multiplexed together within one Physical Channel.

3.9.2 INSERT SERVICE PARAMETERS

3.9.2.1 General

The parameters used by the Insert Service primitives shall conform to the specifications contained in subsections 3.9.2.2 through 3.9.2.4.

3.9.2.2 IN_SDU

The parameter IN_SDU shall be the service data unit transferred by the Insert Service.

NOTE – For restrictions on the IN_SDUs transferred by the Insert Service, see 3.2.7.

3.9.2.3 Physical Channel Name

The Physical Channel Name shall indicate the Physical Channel through which the IN_SDU is to be transferred.

NOTE – The Physical Channel Name is the SAP address of the Insert Service.

3.9.2.4 IN_SDU Loss Flag

The IN_SDU Loss Flag is an optional parameter that may be used to notify the user at the receiving end of the Insert Service that a sequence discontinuity has been detected and that one or more IN_SDUs have been lost. If implemented, the flag shall be derived by a signal given by the underlying Channel Coding Sublayer.

3.9.3 INSERT SERVICE PRIMITIVES

3.9.3.1 General

The service primitives associated with this service are:

- a) INSERT.request;
- b) INSERT.indication.

3.9.3.2 INSERT.request

3.9.3.2.1 Function

At the sending end, the Insert Service user shall pass an INSERT.request primitive to the service provider to request that an IN_SDU be transferred to the user at the receiving end through the specified Physical Channel.

NOTE – The INSERT.request primitive is the service request primitive for the Insert Service.

3.9.3.2.2 Semantics

The INSERT.request primitive shall provide parameters as follows:

| | |
|----------------|------------------------------------|
| INSERT.request | (IN_SDU, Physical Channel Name) |
|----------------|------------------------------------|

3.9.3.2.3 When Generated

The INSERT.request primitive is passed to the service provider to request it to send the IN_SDU.

3.9.3.2.4 Effect On Receipt

Receipt of the INSERT.request primitive causes the service provider to transfer the IN_SDU.

3.9.3.2.5 Additional Comments

The INSERT.request primitive is used to transfer IN_SDUs across the space link on the specified Physical Channel.

3.9.3.3 INSERT.indication

3.9.3.3.1 Function

At the sending end, the service provider shall pass an INSERT.indication to the Insert Service user at the receiving end to deliver an IN_SDU.

NOTE – The INSERT.indication primitive is the service indication primitive for the Insert Service.

3.9.3.3.2 Semantics

The INSERT.indication primitive shall provide parameters as follows:

| | |
|-------------------|--|
| INSERT.indication | (IN_SDU, Physical Channel Name, IN_SDU Loss Flag (optional)) |
|-------------------|--|

3.9.3.3.3 When Generated

The INSERT.indication primitive shall be passed from the service provider to the Insert Service user at the receiving end to deliver an IN_SDU.

3.9.3.3.4 Effect On Receipt

The effect of receipt of the INSERT.indication primitive by the Insert Service user is undefined.

3.9.3.3.5 Additional Comments

The INSERT.indication primitive shall be used to deliver IN_SDUs to the Insert Service user identified by the Physical Channel Name.

4 PROTOCOL SPECIFICATION

4.1 PROTOCOL DATA UNIT

4.1.1 AOS TRANSFER FRAME

4.1.1.1 An AOS Transfer Frame shall encompass the major fields, positioned contiguously, in the following sequence:

- a) Transfer Frame Primary Header (6 or 8 octets; mandatory);
- b) Transfer Frame Insert Zone (integral number of octets; optional);
- c) Transfer Frame Data Field (integral number of octets; mandatory);
- d) Operational Control Field (4 octets; optional);
- e) Frame Error Control Field (2 octets, optional).

4.1.1.2 The AOS Transfer Frame shall be of constant length throughout a specific Mission Phase for any Virtual Channel or Master Channel on a Physical Channel. Its length shall be consistent with the specifications contained in reference [3]. The structural components of the AOS Transfer Frame are shown in figure 4-1.

NOTES

- 1 The protocol data unit of the AOS Space Data Link Protocol is the AOS Transfer Frame. In this Recommendation, the AOS Transfer Frame is also called the Transfer Frame or Frame for simplicity.
- 2 The combination of the Operational Control Field and the Frame Error Control Field is called the Transfer Frame Trailer.
- 3 The start of the Transfer Frame is signaled by the underlying Channel Coding Sublayer.
- 4 A change of Transfer Frame Length may result in a loss of synchronization at the receiver.

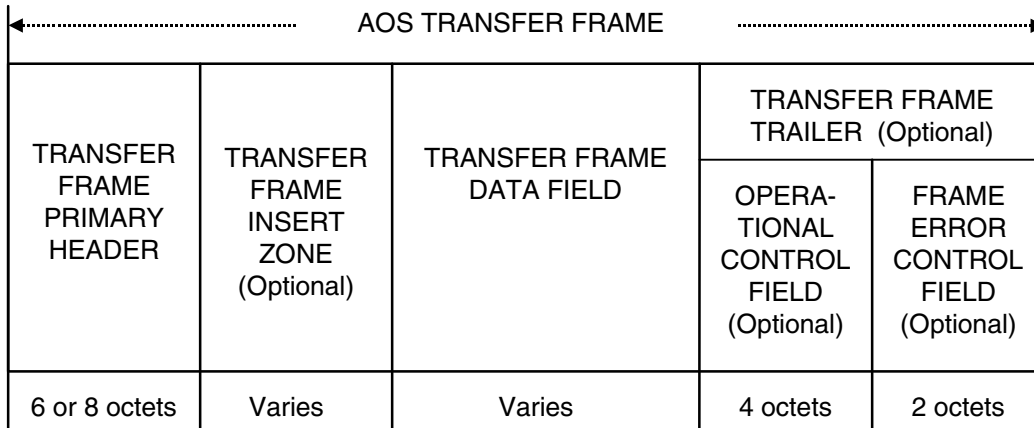

Figure 4-1: AOS Transfer Frame Structural Components

4.1.2 TRANSFER FRAME PRIMARY HEADER

4.1.2.1 General

The Transfer Frame Primary Header is mandatory and shall consist of five fields, positioned contiguously, in the following sequence:

- a) Master Channel Identifier (10 bits; mandatory);
- b) Virtual Channel Identifier (6 bits; mandatory);
- c) Virtual Channel Frame Count (3 octets; mandatory);
- d) Signaling Field (1 octet; mandatory);
- e) Frame Header Error Control (2 octets, optional).

The format of the Transfer Frame Primary Header is shown in figure 4-2.

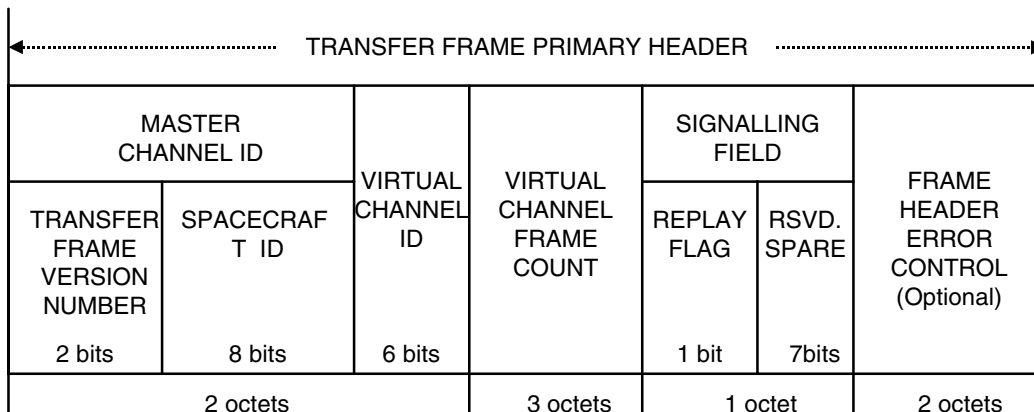

Figure 4-2: Transfer Frame Primary Header

4.1.2.2 Master Channel Identifier

4.1.2.2.1 General

4.1.2.2.1.1 Bits 0–9 of the Transfer Frame Primary Header shall contain the Master Channel Identifier (MCID).

4.1.2.2.1.2 The Master Channel Identifier shall consist of:

- a) Transfer Frame Version Number (2 bits, mandatory);
- b) Spacecraft Identifier (8 bits, mandatory).

4.1.2.2.2 Transfer Frame Version Number

4.1.2.2.2.1 Bits 0–1 of the Transfer Frame Primary Header shall contain the (Binary Encoded) Transfer Frame Version Number.

4.1.2.2.2.2 This 2-bit field shall identify the data unit as a Transfer Frame defined by this Recommendation; it shall be set to ‘01’.

NOTE – This Recommendation defines the Version 2 Synchronous Transfer Frame, whose binary encoded Version Number is ‘01’.

4.1.2.2.3 Spacecraft Identifier

4.1.2.2.3.1 Bits 2–9 of the Transfer Frame Primary Header shall contain the Spacecraft Identifier (SCID).

4.1.2.2.3.2 The Spacecraft Identifier is assigned by CCSDS and shall provide the identification of the spacecraft which is associated with the data contained in the Transfer Frame.

4.1.2.2.3.3 The Spacecraft Identifier shall be static throughout all Mission Phases.

NOTE – The Secretariat of the CCSDS assigns Spacecraft Identifiers according to the procedures in reference [5].

4.1.2.3 Virtual Channel Identifier

4.1.2.3.1 Bits 10–15 of the Transfer Frame Primary Header shall contain the Virtual Channel Identifier (VCID).

4.1.2.3.2 The Virtual Channel Identifier shall be used to identify the Virtual Channel.

NOTES

- 1 If only one Virtual Channel is used, these bits are set permanently to value 'all zeros'. A Virtual Channel used for transmission of Idle Transfer Frames (see 4.1.4) is indicated by setting these bits to the reserved value of 'all ones'.
- 2 There are no restrictions on the selection of Virtual Channel Identifiers except the rules described above. In particular, Virtual Channels are not required to be numbered consecutively.
- 3 A Transfer Frame on the 'Idle' Virtual Channel may not contain any valid user data within its Transfer Frame Data Field, but it must contain the Insert Zone if the Insert Service is supported.

4.1.2.4 Virtual Channel Frame Count

4.1.2.4.1 Bits 16–39 of the Transfer Frame Primary Header shall contain the Virtual Channel Frame Count.

4.1.2.4.2 This 24-bit field shall contain a sequential binary count (modulo-16,777,216) of each Transfer Frame transmitted within a specific Virtual Channel.

4.1.2.4.3 A resetting of the Virtual Channel Frame Count before reaching 16,777,215 shall not take place unless it is unavoidable.

NOTE – The purpose of this field is to provide individual accountability for each Virtual Channel, primarily to enable systematic Packet extraction from the Transfer Frame Data Field. If the Virtual Channel Frame Count is reset because of an unavoidable re-initialization, the completeness of a sequence of Transfer Frames in the related Virtual Channel cannot be determined.

4.1.2.5 Signaling Field**4.1.2.5.1 General**

4.1.2.5.1.1 Bits 40–47 of the Transfer Frame Primary Header shall contain the Signaling Field.

4.1.2.5.1.2 The Signaling Field shall be used to alert the receiver of the Transfer Frames with respect to functions that: (a) may change more rapidly than can be handled by management, or; (b) provide a significant cross-check against manual or automated setups for fault detection and isolation purposes.

4.1.2.5.1.3 This 8-bit field shall be subdivided into two sub-fields as follows:

- a) Replay Flag (1 bit, mandatory);

- b) Reserved Spares (7 bit, mandatory).

4.1.2.5.2 Replay Flag

4.1.2.5.2.1 Bit 40 of the Transfer Frame Primary Header shall contain the Replay Flag.

4.1.2.5.2.2 Recognizing the need to store Transfer Frames during periods when the space link is unavailable, and to retrieve them for subsequent replay when the link is restored, this flag shall alert the receiver of the Transfer Frames with respect to its 'realtime' or 'replay' status. Its main purpose is to discriminate between realtime and replay Transfer Frames when they both may use the same Virtual Channel.

4.1.2.5.2.3 The Replay Flag is interpreted as follows:

- a) '0' = Realtime Transfer Frame;
- b) '1' = Replay Transfer Frame.

NOTES

- 1 Owing to the wide spectrum of onboard storage and retrieval technology options, the exact interpretation of this Flag is necessarily the subject of negotiation between projects and cross-support organizations. For instance, it may be interpreted to indicate that the value of the Virtual Channel Frame Count field on the replayed VC decreases, rather than increases, as a function of reverse playback.
- 2 If Transfer Frames are stored after encoding by the Channel Coding Sublayer, they must be re-encoded if the status of the Replay Flag is altered after retrieval.

4.1.2.5.3 Reserved Spare

4.1.2.5.3.1 Bits 41-47 of the Transfer Frame Primary Header shall contain Reserved Spare.

4.1.2.5.3.2 This seven-bit Reserved Spare field shall be reserved by CCSDS for potential future signaling applications and in the interim shall, by convention, be set to the value 'all zeros'.

4.1.2.6 Frame Header Error Control

4.1.2.6.1 If implemented, Bits 48-63 of the Transfer Frame Primary Header shall contain the Frame Header Error Control.

NOTE – The 10-bit Master Channel Identifier, the 6-bit Virtual Channel Identifier, and the 8-bit Signaling Field may all be protected by an optional error detecting and correcting code, whose check symbols are contained within this 16-bit field.

4.1.2.6.2 The presence or absence of the optional Frame Header Error Control shall be established by management.

4.1.2.6.3 If present, the Frame Header Error Control shall exist in every Transfer Frame transmitted within the same Physical Channel.

4.1.2.6.4 Once set by management, the presence or absence of the Frame Header Error Control shall be static throughout a Mission Phase.

4.1.2.6.5 The mechanism for generating the Frame Header Error Control shall be a shortened Reed-Solomon (10,6) code. The parameters of the selected code are as follows:

- a) 'J=4' bits per Reed-Solomon (R-S) symbol.
- b) 'E=2' symbol error correction capability within an R-S code word.
- c) The field generator polynomial shall be:

$$F(X) = x^4 + x + 1$$

over GF(2)

- d) The code generator polynomial shall be:

$$g(x) = (x + \alpha^6)(x + \alpha^7)(x + \alpha^8)(x + \alpha^9)$$

over GF(2⁴)

where $F(\alpha) = 0$,

$$\alpha^6 = 1100, \alpha^7 = 1011$$

$$\alpha^8 = 0101, \alpha^9 = 1010$$

also:

$$g(x) = x^4 + \alpha^3 x^3 + \alpha x^2 + \alpha^3 x + 1$$

over GF(2⁴)

and:

$$\alpha^0 = 0001, \alpha^3 = 1000$$

$$\alpha = 0010$$

- e) Within an R-S symbol, the transmission shall start from the bit on the left side; e.g.,

$$\alpha^3 = 1000$$

shall be transmitted as a 1 followed by three 0s.

f) The bit to R-S symbol mapping shall be:

| <u>bits in the header</u> | <u>symbol</u> |
|---------------------------|---------------|
| 0,1,2,3 | 0 |
| 4,5,6,7 | 1 |
| 8,9,10,11 | 2 |
| 12,13,14,15 | 3 |
| 40,41,42,43 | 4 |
| 44,45,46,47 | 5 |
| 48,49,50,51 | 6 |
| 52,53,54,55 | 7 |
| 56,57,58,59 | 8 |
| 60,61,62,63 | 9 |

NOTES

- 1 The purpose of this field is to provide a capability for protecting some key elements in the Transfer Frame Primary Header.
- 2 Whether this field should be used on a particular Physical Channel shall be determined based on the mission requirements for data quality and the selected options for the Channel Coding Sublayer.
- 3 The header error correction code can correct up to and including two symbol errors. This is sufficient to meet the performance of $<1 \times 10^{-7}$ Data Fields missing at a 1×10^{-5} channel bit error rate, for random bit errors. In the case of convolutional coded channels, in particular when the convolutional coding is interleaved, the Data Field loss rate will drop to 2×10^{-5} at an operating point equivalent to a channel bit error rate of 1×10^{-5} . This is due to the burst errors typical of the convolutional decoders.

4.1.3 TRANSFER FRAME INSERT ZONE

4.1.3.1 If implemented, the Transfer Frame Insert Zone shall follow, without gap, the Transfer Frame Primary Header.

4.1.3.2 The presence or absence of the optional Transfer Frame Insert Zone shall be established by management.

4.1.3.3 If the Physical Channel supports the Insert Service for transfer of periodic data, then the Insert Zone shall exist in every Transfer Frame transmitted within the same Physical Channel, including Idle Transfer Frames.

4.1.3.4 Once set by management, the presence or absence of the Insert Zone shall be static throughout a Mission Phase.

4.1.3.4.1 The length of the Insert Zone shall be set by management to be equal to the constant length of the Insert Service Data Unit (IN_SDU) for that Physical Channel. The Insert Zone shall contain precisely one octet-aligned IN_SDU.

4.1.3.4.2 Once set by management, the length of the Insert Zone shall be static throughout a Mission Phase.

NOTE – If the Insert Zone is present, management reduces the length of the Transfer Frame Data Field that is available to other service users by an amount equal to the constant length of the Insert Zone.

4.1.4 TRANSFER FRAME DATA FIELD

4.1.4.1 Overview

4.1.4.1.1 The Transfer Frame Data Field shall follow, without gap, the Transfer Frame Primary Header or the Transfer Frame Insert Zone, if present.

4.1.4.1.2 The Transfer Frame Data Field, which shall contain an integer number of octets, shall have a length which varies and is equal to:

- a) the fixed Transfer Frame length which has been selected for use on a particular Physical Channel; minus
- b) the length of the Transfer Frame Primary Header plus the length of the Transfer Frame Insert Zone and/or the Transfer Frame Trailer (if any of these are present).

4.1.4.1.3 The Transfer Frame Data Field shall contain one Multiplexing Protocol Data Unit (M_PDU), one Bitstream Protocol Data Unit (B_PDU), one Virtual Channel Access Service Data Unit (VCA_SDU), or Idle Data.

4.1.4.1.4 M_PDUs, B_PDUs, VCA_SDUs, and Idle Data shall not be mixed in a Virtual Channel (i.e., if a Virtual Channel transfers M_PDUs, every Transfer Frame of that Virtual Channel shall contain an M_PDU). Management shall decide whether M_PDUs, B_PDUs or VCA_SDUs are transferred on a particular Virtual Channel, and this decision shall remain static throughout a Mission Phase.

4.1.4.1.5 In the case where no valid Transfer Frame Data Field is available for transmission at release time for a Transfer Frame, a Transfer Frame with a Data Field containing only Idle Data shall be transmitted. Such a Transfer Frame is called an Idle Transfer Frame. The Virtual Channel ID of an Idle Transfer Frame shall be set to the value of ‘all ones’ and a project-specified ‘idle’ pattern shall be inserted into the Transfer Frame Data Field.

NOTES

- 1 Transfer Frames containing Idle Data in their Data Fields are sent to maintain synchronization at the receiver and also to transmit data in the Transfer Frame Insert Zone when there is no Data Field to send.
- 2 Idle Data in the Transfer Frame Data Field of an Idle Transfer Frame must not be confused with the Idle Packet specified in reference [6].

4.1.4.2 Multiplexing Protocol Data Unit

4.1.4.2.1 Overview

4.1.4.2.1.1 The Multiplexing Protocol Data Unit (M_PDU) shall follow, without gap, the Transfer Frame Primary Header or the Transfer Frame Insert Zone if present.

4.1.4.2.1.2 The length of the M_PDU shall be fixed by management for any particular Virtual Channel, since it is required to fit exactly within the fixed-length Transfer Frame Data Field.

NOTE – The length of M_PDUs carried by a Physical Channel which supports the Insert Service must take into account the fixed length of the optional Insert Zone.

4.1.4.2.1.3 The M_PDU shall be divided as follows:

- a) M_PDU Header (2 octets, mandatory);
- b) M_PDU Packet Zone (integral number of octets, mandatory).

4.1.4.2.1.4 The M_PDU Header shall be sub-divided as follows:

- a) Reserved Spare (5 bits, mandatory);
- b) First Header Pointer (11 bits, mandatory).

4.1.4.2.1.5 The format of the M_PDU is shown in figure 4-3.

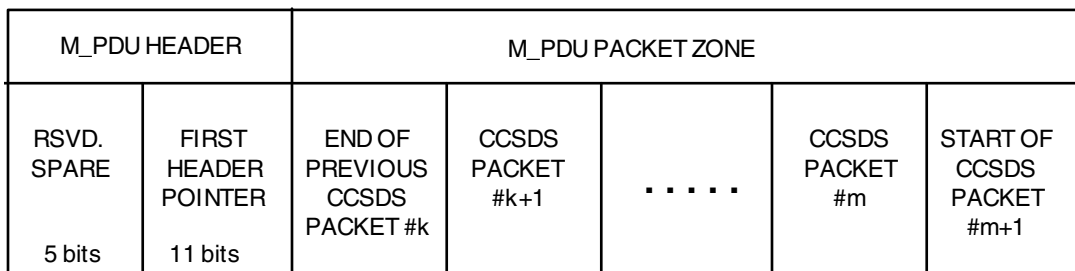

Figure 4-3: Multiplexing Protocol Data Unit (M_PDU)

4.1.4.2.2 Reserved Spare

4.1.4.2.2.1 Bits 0–4 of the M_PDU Header shall contain the Reserved Spare.

4.1.4.2.2.2 This five-bit Reserved Spare field is currently undefined by CCSDS; by convention, it shall therefore be set to the reserved value of ‘00000’.

4.1.4.2.3 First Header Pointer

4.1.4.2.3.1 Bits 5–15 of the M_PDU Header shall contain the First Header Pointer.

4.1.4.2.3.2 The First Header Pointer shall contain the position of the first octet of the first Packet that starts in the M_PDU Packet Zone.

4.1.4.2.3.3 The locations of the octets in the M_PDU Packet Zone shall be numbered in ascending order. The first octet in this zone is assigned the number 0. The First Header Pointer shall contain the binary representation of the location of the first octet of the first Packet that starts in the M_PDU Packet Zone.

NOTES

- 1 The purpose of the First Header Pointer is to facilitate delimiting of variable-length Packets contained within the M_PDU Packet Zone, by pointing directly to the location of the first Packet from which its length may be determined.
- 2 The locations of any subsequent Packets within the same M_PDU Packet Zone will be determined by calculating the locations using the length field of these Packets.
- 3 If the last Packet in the M_PDU Packet Zone of Transfer Frame N spills over into Frame M of the same Virtual Channel ($N < M$), then the First Header Pointer in Frame M ignores the residue of the split Packet and indicates the start of the next Packet that starts in Frame M .

4.1.4.2.3.4 If no Packet starts in the M_PDU Packet Zone, the First Header Pointer shall be set to ‘all ones’.

NOTE – The above situation may occur if a long Packet extends across more than one Transfer Frame.

4.1.4.2.3.5 If the M_PDU Packet Zone contains only Idle Data, the First Header Pointer shall be set to ‘all ones minus one’.

4.1.4.2.4 M_PDU Packet Zone

4.1.4.2.4.1 The M_PDU Packet Zone shall follow, without gap, the M_PDU Header.

4.1.4.2.4.2 The M_PDU Packet Zone shall contain either Packets or Idle Data (a fixed-length project-specified 'idle' pattern).

4.1.4.2.4.3 Packets shall be inserted contiguously and in forward order into the M_PDU Packet Zone.

NOTE – The first and last Packets of the M_PDU are not necessarily complete, since the first Packet may be a continuation of a Packet begun in the previous M_PDU, and the last Packet may continue in the subsequent M_PDU of the same Virtual Channel.

4.1.4.2.4.4 When insufficient Packets (including Idle Packets) are available at release time of a Transfer Frame of a Virtual Channel carrying M_PDUs, an M_PDU that contains only Idle Data in its Packet Zone shall be generated.

NOTES

- 1 M_PDUs that contain only Idle Data in their Packet Zones are sent to maintain synchronous transmission of Transfer Frames and also to transmit data in the Operational Control Field on a specific Virtual Channel when there is no Packet to send.
- 2 An M_PDU that contains only Idle Data in its Packet Zone can be generated whenever it is necessary (even in the middle of transmission of a Packet that is split into multiple M_PDUs).
- 3 An M_PDU that contains only Idle Data in its Packet Zone must not be confused with the Idle Transfer Frame defined in 4.1.4.
- 4 Idle Data in the M_PDU Packet Zone should not be confused with the Idle Packet specified in reference [4].

4.1.4.3 Bitstream Protocol Data Unit

4.1.4.3.1 Overview

4.1.4.3.1.1 The Bitstream Protocol Data Unit (B_PDU) shall follow, without gap, the Transfer Frame Primary Header or the Transfer Frame Insert Zone if present.

4.1.4.3.1.2 The length of the B_PDU shall be fixed by management for any particular Virtual Channel, since it is required to fit exactly within the fixed-length Transfer Frame Data Field.

NOTE – The length of B_PDUs carried by a Physical Channel which supports the Insert Service must take into account the fixed length of the optional Insert Zone.

4.1.4.3.1.3 The B_PDU shall be divided as follows:

- a) B_PDU Header (2 octets, mandatory);
- b) B_PDU Bitstream Data Zone (integral number of octets, mandatory).

4.1.4.3.1.4 The B_PDU Header shall be subdivided as follows:

- a) Reserved Spare (2 bits, mandatory);
- b) Bitstream Data Pointer (14 bits, mandatory).

4.1.4.3.1.5 The format of the B_PDU is shown in figure 4-4.

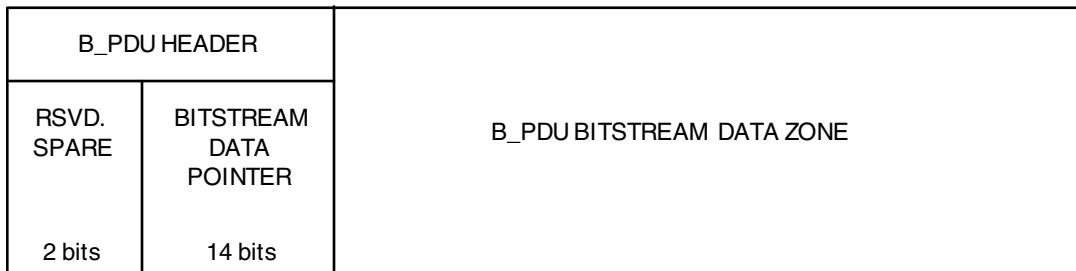

Figure 4-4: Bitstream Protocol Data Unit (B_PDU)

4.1.4.3.2 Reserved Spare

4.1.4.3.2.1 Bits 0–1 of the B_PDU Header shall contain the Reserved Spare.

4.1.4.3.2.2 This two-bit Reserved Spare field is currently undefined by CCSDS; by convention, it shall therefore be set to the reserved value of ‘00’.

4.1.4.3.3 Bitstream Data Pointer

4.1.4.3.3.1 Bits 2–15 of the B_PDU Header shall contain the Bitstream Data Pointer.

NOTE – Because it may be necessary to insert idle data if an insufficient number of Bitstream Data bits have been received before a B_PDU is released for transmission, the Bitstream Data Pointer indicates the location of the last valid user data bit within the B_PDU Bitstream Data Zone (i.e., the boundary between user data and any inserted idle data).

4.1.4.3.3.2 The locations of the bits in the B_PDU Bitstream Data Zone shall be numbered in ascending order. The first bit in this zone is assigned the number 0. The Bitstream Data Pointer shall contain the binary representation of the location of the last valid user data bit within B_PDU Bitstream Data Zone.

4.1.4.3.3.3 If there are no idle data in the Bitstream Data Zone (i.e., the B_PDU contains only valid user data), the Bitstream Data Pointer shall be set to the value ‘all ones’.

4.1.4.3.3.4 If there are no valid user data in the Bitstream Data Zone (i.e., the B_PDU contains only idle data), the Bitstream Data Pointer shall be set to the value ‘all ones minus one’.

4.1.4.3.4 B_PDU Bitstream Data Zone

4.1.4.3.4.1 The B_PDU Bitstream Data Zone shall follow, without gap, the B_PDU Header.

4.1.4.3.4.2 The Bitstream Data Zone shall contain either a fixed-length block of the user Bitstream Data (possibly terminated with idle data at a location delimited by the Bitstream Data Pointer), or Idle Data (a fixed-length project-specified ‘idle’ pattern).

4.1.4.3.4.3 When no Bitstream Data are available at release time of a Transfer Frame of a Virtual Channel carrying B_PDUs, a B_PDU that contains only Idle Data in its Data Zone shall be generated.

NOTES

- 1 B_PDUs that contain only Idle Data in its Data Zone are sent to maintain synchronous transmission of Transfer Frames, and also to transmit data in the Operational Control Field on a specific Virtual Channel when there are no Bitstream Data to send.
- 2 A B_PDU that contains only Idle Data in its Data Zone must not be confused with the Idle Transfer Frame defined in 4.1.4.

4.1.5 OPERATIONAL CONTROL FIELD

4.1.5.1 If present, the Operational Control Field shall occupy the four octets following, without gap, the Transfer Frame Data Field.

4.1.5.2 The Operational Control Field is optional; its presence or absence is established by management for each Virtual Channel.

4.1.5.3 If the Operational Control Field is present on a Virtual Channel, it shall occur within every Transfer Frame transmitted through the Virtual Channel throughout a Mission Phase.

4.1.5.4 The leading bit of the field, i.e., bit 0, shall contain a Type Flag with the following meanings:

- a) the Type Flag shall be ‘0’, if the Operational Control Field holds a Type-1-Report which shall contain a Communications Link Control Word, the content of which is defined in reference [B5];
- b) the Type Flag shall be ‘1’, if the Operational Control Field holds a Type-2-Report.

NOTE – The Type Flag may vary between Transfer Frames on the same Virtual Channel that carries this field.

4.1.5.5 The first bit of a Type-2-Report (i.e., bit 1 of the Operational Control Field) shall indicate the use of this report as follows:

- a) if this bit is '0', the contents of the report are project-specific;
- b) if this bit is '1', the contents of the report are reserved by CCSDS for future application.

NOTES

- 1 The value of the first bit of a Type-2-Report may vary between Transfer Frames on the same Virtual Channel that carries this field.
- 2 The purpose of this field is to provide a standardized mechanism for reporting a small number of real-time functions (such as retransmission control or spacecraft clock calibration); currently the use for retransmission control (Type-1-Reports) has been defined by CCSDS in reference [B5]. This issue of the Recommendation does not define the use of Type-2-Reports; however, it reserves the possibility to do so in future issues by restricting the utilization of the first bit.

4.1.6 FRAME ERROR CONTROL FIELD

4.1.6.1 General

4.1.6.1.1 If present, the Frame Error Control Field shall occupy the two octets following, without gap, the Operational Control Field if this is present, or the Transfer Frame Data Field if an Operational Control Field is not present.

4.1.6.1.2 The Frame Error Control Field is optional; its presence or absence shall be established by management.

4.1.6.1.3 If present, the Frame Error Control Field shall occur within every Transfer Frame transmitted within the same Physical Channel throughout a Mission Phase.

NOTES

- 1 The purpose of this field is to provide a capability for detecting errors which may have been introduced into the Transfer Frame during the transmission and data handling process.
- 2 Whether this field should be used on a particular Physical Channel shall be determined based on the mission requirements for data quality and the selected options for the underlying Channel Coding Sublayer. This field may be mandatory depending on the selected options for the Channel Coding Sublayer.

4.1.6.2 Frame Error Control Field Encoding Procedure

4.1.6.2.1 The Encoding Procedure shall accept an $(n-16)$ -bit Transfer Frame, excluding the Frame Error Control Field, and generates a systematic binary $(n, n-16)$ block code by appending a 16-bit Frame Error Control Field as the final 16 bits of the codeblock, where n is the length of the Transfer Frame.

4.1.6.2.2 The equation for the contents of the Frame Error Control Field is:

$$\text{FECF} = [(X^{16} \cdot M(X)) + (X^{(n-16)} \cdot L(X))] \text{ modulo } G(X)$$

where

all arithmetic is modulo 2;

n is the number of bits in the encoded message;

$M(X)$ is the $(n-16)$ -bit message to be encoded expressed as a polynomial with binary coefficients;

$L(X)$ is the presetting polynomial given by

$$L(X) = \sum_{i=0}^{15} x_i ;$$

$G(X)$ is the generating polynomial given by

$$G(X) = X^{16} + X^{12} + X^5 + 1.$$

NOTE – The $X^{(n-16)} \cdot L(X)$ term has the effect of presetting the shift register to all ‘1’ state prior to encoding.

4.1.6.3 Frame Error Control Field Decoding Procedure

The error detection syndrome, $S(X)$, is given by

$$S(X) = [(X^{16} \cdot C^*(X)) + (X^n \cdot L(X))] \text{ modulo } G(X)$$

where

- $C^*(X)$ is the received block, including the Frame Error Control Field, in polynomial form; and
- $S(X)$ is the syndrome polynomial which will be zero if no error is detected and non-zero if an error is detected.

4.2 PROTOCOL PROCEDURES AT THE SENDING END

4.2.1 OVERVIEW

This subsection describes procedures at the sending end associated with each of the functions shown in figure 4-5. In this figure, data flow from top to bottom of the figure. This figure identifies data-handling functions performed by the protocol entity at the sending end, and shows logical relationships among these functions. This figure is not intended to imply any hardware or software configuration in a real system. Depending on the services actually used for a real system, not all of the functions may be present in the protocol entity. The procedures described in this subsection are defined in an abstract sense and are not intended to imply any particular implementation approach of a protocol entity.

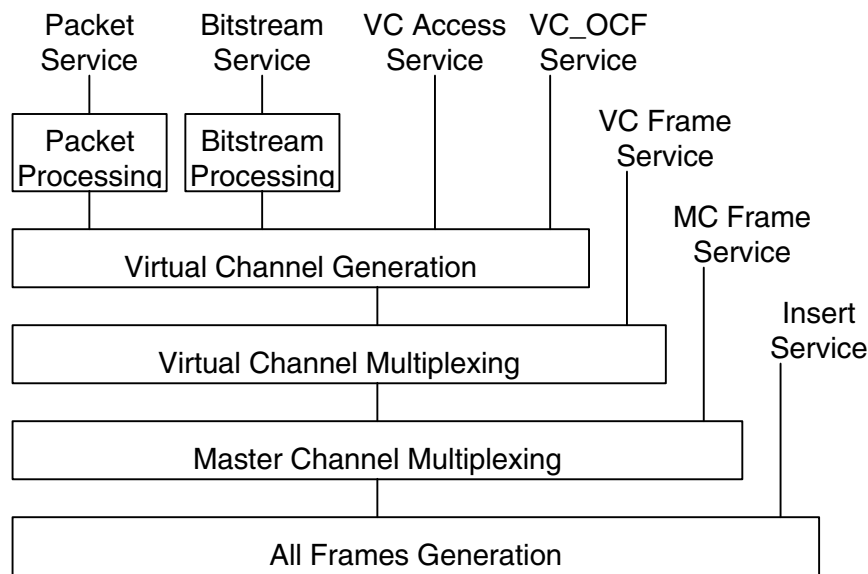

Figure 4-5: Internal Organization of Protocol Entity (Sending End)

4.2.2 PACKET PROCESSING FUNCTION

4.2.2.1 The Packet Processing Function shall be used to transfer variable-length Packets in the fixed-length M_PDU of Transfer Frames.

NOTE – There is an instance of the Packet Processing Function for each Virtual Channel that carries Packets.

4.2.2.2 The M_PDUs shall be constructed by concatenating Packets together until the maximum M_PDU length is exceeded. Any Packet which exceeds the maximum M_PDU length shall be split, filling the M_PDU completely, and starting a new M_PDU on the same Virtual Channel with the remainder. Construction of the next M_PDU shall continue with the concatenation of Packets until it overflows.

4.2.2.3 If Packets of multiple versions are to be transferred on a Virtual Channel, Packets of these versions shall be multiplexed into a contiguous string of Packets before constructing M_PDUs.

4.2.2.4 The ‘First Header Pointer’ field shall be set to indicate the location of the first octet of the first Packet occurring within the M_PDU Packet Zone.

4.2.2.5 The Packet Processing Function may generate ‘idle’ data in the absence of sufficient Packets supplied from the users at release time. The mechanism for generating idle data shall be to create an Idle Packet of appropriate length defined by reference [3].

NOTE – The shortest Idle Packet is 7-octets long (i.e., a 6-octet header plus 1 octet of idle data). If the area to be filled in an M_PDU is less than 7 octets, then the Idle Packet will spill over into the beginning of the next M_PDU.

4.2.2.6 If it is necessary, the Packet Processing Function may generate an ‘idle’ M_PDU by setting the First Header Pointer to ‘all ones minus one’. An abstract model of the Packet Processing Function is illustrated in figure 4-6.

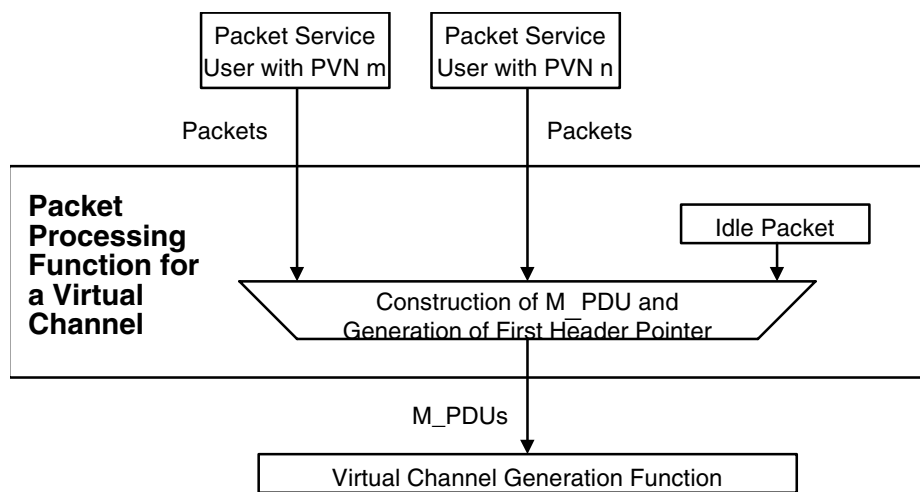

Figure 4-6: Abstract Model of Packet Processing Function

4.2.3 BITSTREAM PROCESSING FUNCTION

4.2.3.1 The Bitstream Processing Function shall be used to transfer variable-length streams of bits in the fixed-length B_PDU of Transfer Frames.

NOTE – There is an instance of the Bitstream Processing Function for each Virtual Channel that carries Bitstream Data.

4.2.3.2 The Bitstream Processing Function shall be used to fill the Bitstream Data Zone of the B_PDU with the Bitstream Data supplied by the user. Each bit shall be placed sequentially, and unchanged, into the B_PDU Bitstream Data Zone. When the Bitstream

Data have filled one particular B_PDU, the continuation of the Bitstream Data shall be placed in a new B_PDU on the same Virtual Channel.

NOTE – If, because of the constraints of the Transfer Frame release algorithm, a B_PDU is not completely filled by Bitstream Data at release time, the Bitstream Processing Function will fill the remainder of the B_PDU with a locally specified idle pattern. The boundary between the end of the valid Bitstream Data and the beginning of the idle data is indicated by setting a Bitstream Data Pointer in the B_PDU Header. If it is necessary, the Bitstream Processing Function may generate an ‘idle’ B_PDU by setting the Bitstream Data Pointer to ‘all ones minus one’.

4.2.3.3 The length of the B_PDU must be equal to the length of the Transfer Frame Data Field for the Virtual Channel identified by the GVCID. An abstract model of the Bitstream Processing Function is illustrated in figure 4-7.

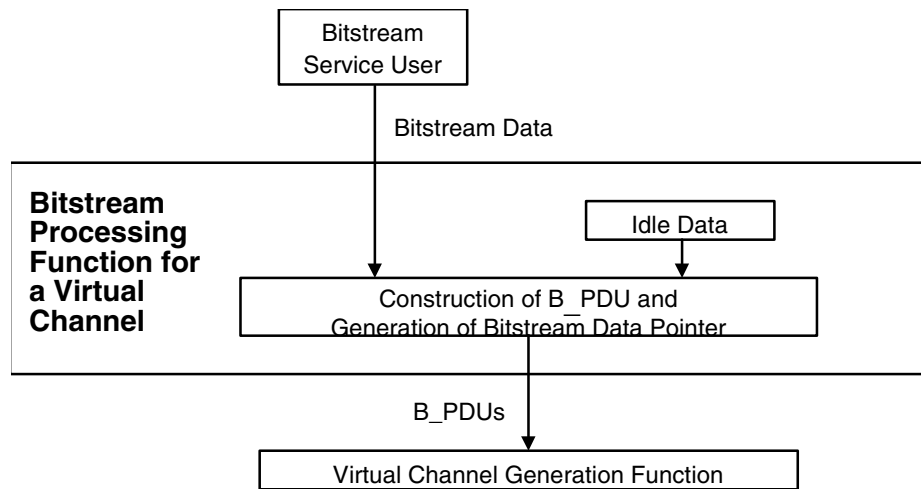

Figure 4-7: Abstract Model of Bitstream Processing Function

4.2.4 VIRTUAL CHANNEL GENERATION FUNCTION

NOTE – The Virtual Channel Generation Function is used to build the basic structure of Transfer Frames. It is also used to build the structure and the Primary Header of the Transfer Frames for transmission on each Virtual Channel. There is an instance of the Virtual Channel Generation Function for each Virtual Channel.

4.2.4.1 Transfer Frames shall be assembled by placing a single M_PDU, B_PDU or VCA_SDU, unchanged, into the Transfer Frame Data Field and generating the Transfer Frame Primary Header fields. A Virtual Channel Frame Count shall be generated independently for each Virtual Channel and placed into the Primary Header.

4.2.4.2 If there is a user of the VC_OCF Service for a particular Virtual Channel, an OCF_SDU supplied by the user shall be placed in the Operational Control Field.

4.2.4.3 The Insert Zone and the Frame Error Control Field of Transfer Frames, if present for a particular Physical Channel, shall be kept empty by the Virtual Channel Generation Function. An abstract model of the Virtual Channel Generation Function is illustrated in figure 4-8.

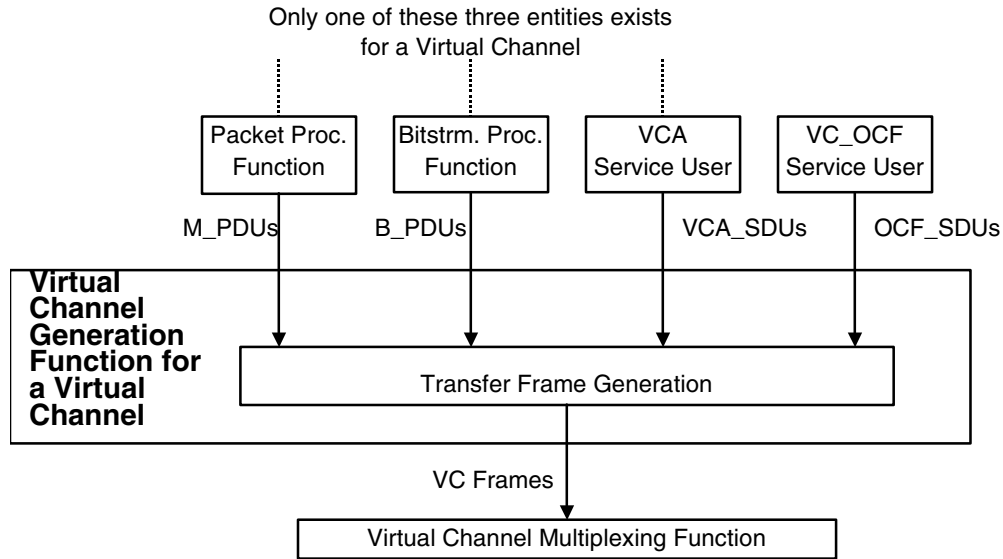

Figure 4-8: Abstract Model of Virtual Channel Generation Function

4.2.5 VIRTUAL CHANNEL MULTIPLEXING FUNCTION

4.2.5.1 The Virtual Channel Multiplexing Function shall be used to multiplex Transfer Frames of different Virtual Channels of a Master Channel.

NOTE – There is an instance of the Virtual Channel Multiplexing Function for each Master Channel that has multiple Virtual Channels.

4.2.5.2 The Virtual Channel Multiplexing Function shall multiplex Transfer Frames received from the instances of the Virtual Channel Generation Function and, if present, the Virtual Channel Frame Service users, and shall put them into a queue of Transfer Frames in an appropriate order that is set by management.

4.2.5.3 The algorithm used to order the Transfer Frames is not specified by CCSDS, but shall be defined by project organizations considering factors such as priority, release rate, isochronous timing requirements, etc.

4.2.5.4 If there is only one Master Channel on the Physical Channel, then the Virtual Channel Multiplexing Function shall create an Idle Transfer Frame to preserve the continuity of the transmitted stream in the event that there are no valid Transfer Frames available for transmission at a release time.

4.2.5.5 The Idle Transfer Frame shall have its VCID set to the reserved value of ‘all ones’. It is not required to maintain a Virtual Channel Frame Count for Idle Transfer Frames.

4.2.5.6 An abstract model of the Virtual Channel Multiplexing Function is illustrated in figure 4-9.

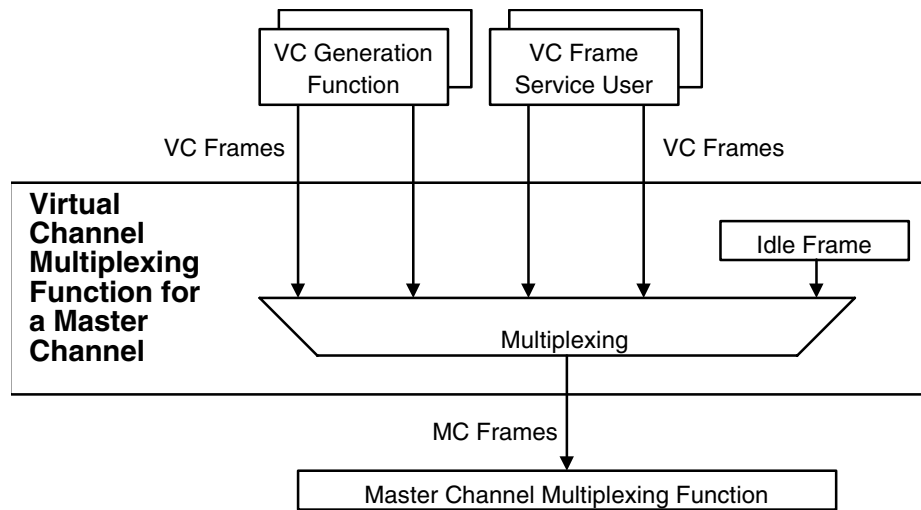

Figure 4-9: Abstract Model of Virtual Channel Multiplexing Function

4.2.6 MASTER CHANNEL MULTIPLEXING FUNCTION

4.2.6.1 The Master Channel Multiplexing Function shall be used to multiplex Transfer Frames of different Master Channels of a Physical Channel.

NOTE – There is an instance of the Master Channel Multiplexing Function for each Physical Channel that has multiple Master Channels.

4.2.6.2 The Master Channel Multiplexing Function shall multiplex Transfer Frames received from the instances of the Virtual Channel Multiplexing Function and, if present, the Master Channel Frame Service users, and shall put them into a queue of Transfer Frames in an appropriate order that is set by management.

4.2.6.3 The algorithm to be used to order the Transfer Frames is not specified by CCSDS, but shall be defined by project organizations considering factors such as priority, release rate, isochronous timing requirements, etc.

4.2.6.4 The Master Channel Multiplexing Function shall create an Idle Transfer Frame to preserve the continuity of the transmitted stream in the event that there are no valid Transfer Frames available for transmission at a release time. The Idle Transfer Frame shall have its VCID set to the reserved value of ‘all ones’ and its MCID set to one of the allowable values. It is not required to maintain a Virtual Channel Frame Count for Idle Transfer Frames.

4.2.6.5 An abstract model of the Master Channel Multiplexing Function is illustrated in figure 4-10.

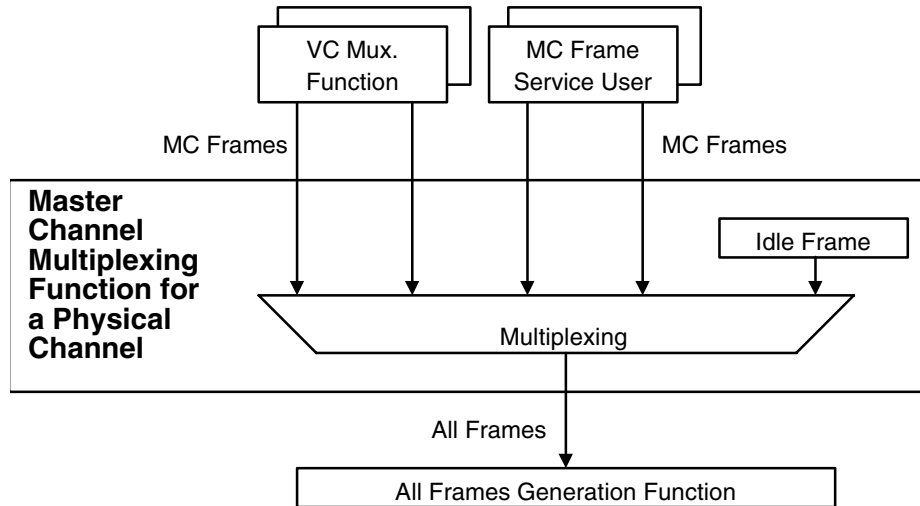

Figure 4-10: Abstract Model of Master Channel Multiplexing Function

4.2.7 ALL FRAMES GENERATION FUNCTION

4.2.7.1 The All Frames Generation Function shall be used to insert Insert service data units into Transfer Frames of a Physical Channel. It shall also be used to perform error control encoding defined by this Recommendation.

NOTE – There is an instance of the All Frames Generation Function for each Physical Channel.

4.2.7.2 If the optional Insert Service is activated, a fixed-length Insert Zone shall exist in every Transfer Frame that is transmitted in a particular Physical Channel. The IN_SDUs shall be timed to arrive at a constant interval that corresponds to the release time of the Transfer Frames onto the Physical Channel. The All Frames Generation Function shall place the IN_SDUs, received from the Insert Service user, into the Insert Zone of the Transfer Frames, preserving octet alignment.

4.2.7.3 If the Frame Header Error Control is present, check bits shall be generated using the encoding procedure described in 4.1.2.6 and added to the Transfer Frame Primary Header. If this field is present, it must be present in all the Transfer Frames transmitted in a particular Physical Channel.

4.2.7.4 If the Frame Error Control Field is present, check bits shall be generated using the encoding procedure described in 4.1.6.2 and inserted into the Transfer Frame Trailer. If this field is present, it must be present in all the Transfer Frames transmitted in a particular Physical Channel.

4.2.7.5 Externally generated Transfer Frames associated with the Virtual Channel Frame and Mater Channel Frame Services shall always bypass the error control encoding functions specified above. The users of these Services must therefore ensure that the Transfer Frames contain an error control option which conforms with that used by the service provider for the same Physical Channel. An abstract model of the All Frames Generation Function is illustrated in figure 4-11.

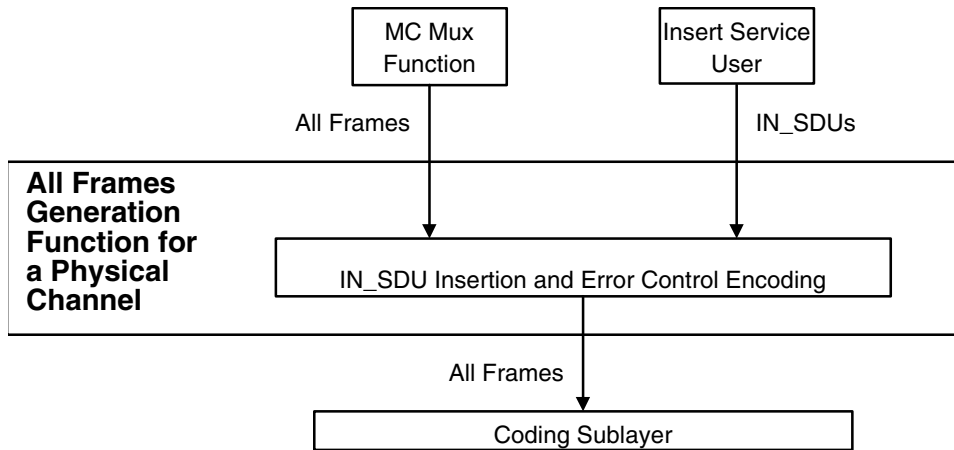

Figure 4-11: Abstract Model of All Frames Generation Function

4.3 PROTOCOL PROCEDURES AT THE RECEIVING END

4.3.1 OVERVIEW

This subsection describes procedures at the receiving end associated with each of the functions shown in figure 4-12. In this figure, data flow from bottom to top of the figure. This figure identifies data-handling functions performed by the protocol entity at the receiving end, and shows logical relationships among these functions. This figure is not intended to imply any hardware or software configuration in a real system. Depending on the services actually used for a real system, not all of the functions may be present in the protocol entity. The procedures described in this subsection are defined in an abstract sense and are not intended to imply any particular implementation approach of a protocol entity.

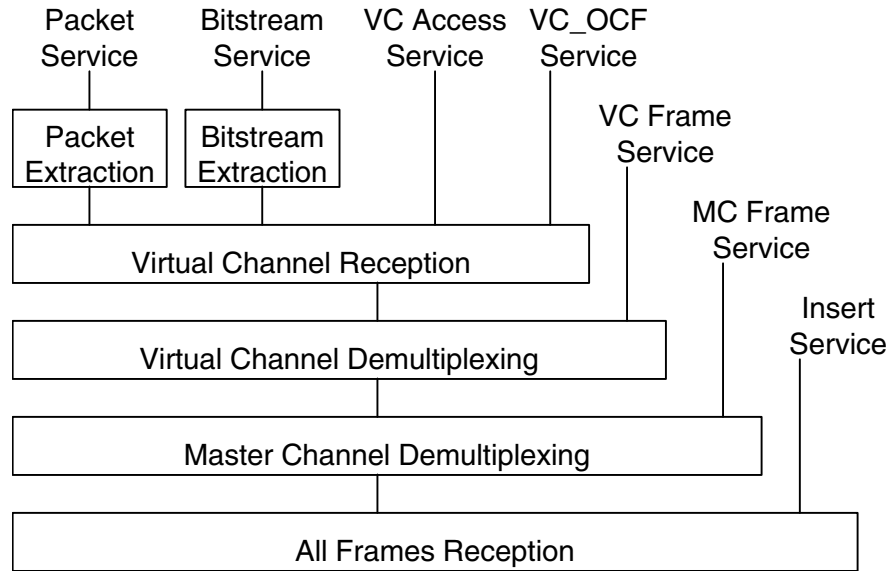

Figure 4-12: Internal Organization of Protocol Entity (Receiving End)

4.3.2 PACKET EXTRACTION FUNCTION

4.3.2.1 The Packet Extraction Function is used to extract variable-length Packets from the fixed-length M_PDU.

NOTE – There is an instance of the Packet Extraction Function for each Virtual Channel that carries Packets.

4.3.2.2 The Packet Extraction Function shall extract Packets from M_PDU received from the Virtual Channel Reception Function. The First Header Pointer of each M_PDU shall be used in conjunction with the length field of each Packet contained within the M_PDU to provide the delimiting information needed to extract Packets.

4.3.2.3 If the last Packet removed from the M_PDU is incomplete, the Packet Extraction Function shall retrieve its remainder from the beginning of the next M_PDU received on the same Virtual Channel. The First Header Pointer for the next M_PDU shall be used to determine the length of the remainder and, hence, the beginning of the next Packet to be extracted.

4.3.2.4 If the calculated location of the beginning of the first Packet is not consistent with the location indicated by the First Header Pointer, the Packet Extraction Function shall assume that the First Header Pointer is correct, and shall continue the extraction based on that assumption.

4.3.2.5 Extracted Packets shall be delivered to the users on the basis of the Packet Version Number in their header.

NOTE – Incomplete Packets are not required to be delivered in cross support situations. Idle Packets are discarded. M_PDUs that contain only Idle Data are also discarded.

4.3.2.6 An abstract model of the Packet Extraction Function is illustrated in figure 4-13.

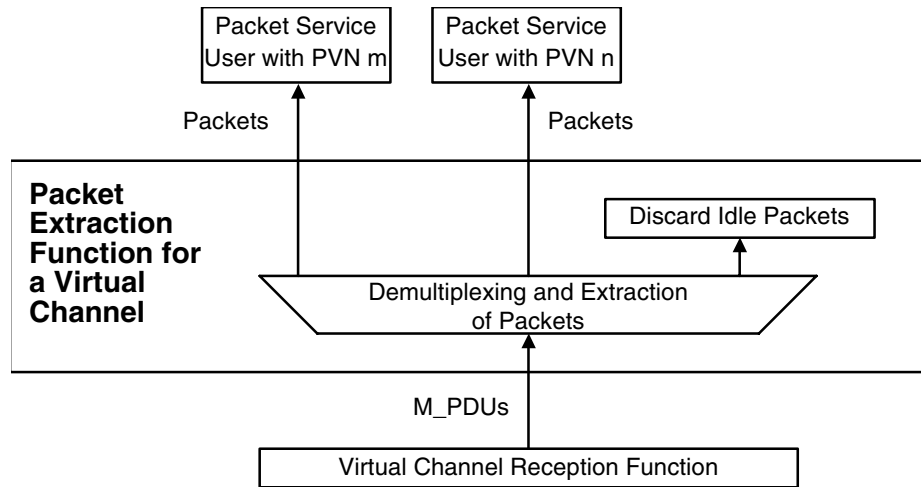

Figure 4-13: Abstract Model of Packet Extraction Function

4.3.3 BITSTREAM EXTRACTION FUNCTION

4.3.3.1 The Bitstream Extraction Function shall be used to extract variable-length Bitstream Data from fixed-length B_PDUs.

NOTE – There is an instance of the Bitstream Processing Function for each Virtual Channel that carries Bitstream Data.

4.3.3.2 The Bitstream Extraction Function shall be used to extract Bitstream Data from B_PDUs received from the Virtual Channel Reception Function. The extracted Bitstream Data shall be delivered to the Bitstream service user identified by the GVCID. Any idle data inserted by the sending end shall be removed and discarded prior to delivery, using the Bitstream Data Pointer information.

4.3.3.3 The Bitstream Extraction Function may optionally pass a Bitstream Data Loss Flag to the user of the Bitstream Service as a parameter; the flag is derived from the Loss Flag received from the Virtual Channel Reception Function.

NOTE – If used, the Bitstream Data Loss Flag indicates to the user that an indeterminate amount of Bitstream Data may have been lost. Note that if the Bitstream Data Loss Flag is set, and (one or more) subsequent B_PDUs are discarded because they contain only idle data, then the Flag must remain set until the next valid Bitstream Data is delivered to the user.

4.3.3.4 An abstract model of the Bitstream Extraction Function is illustrated in figure 4-14.

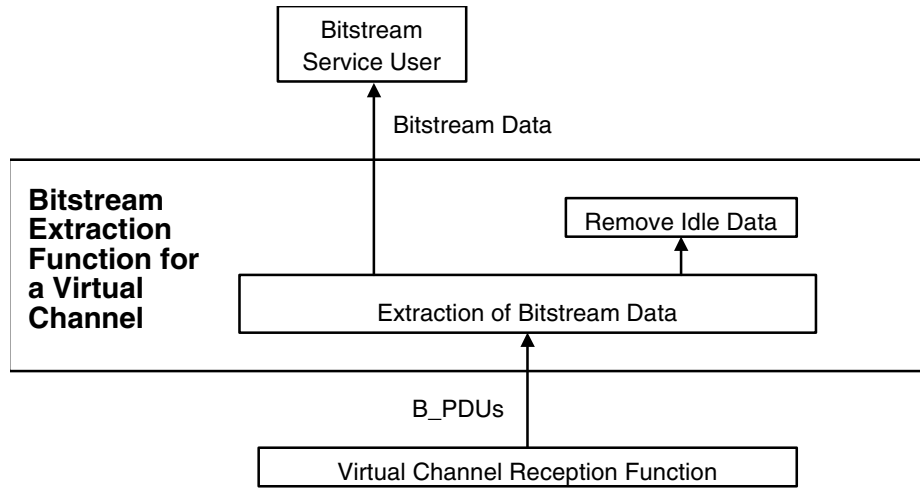

Figure 4-14: Abstract Model of Bitstream Reception Function

4.3.4 VIRTUAL CHANNEL RECEPTION FUNCTION

4.3.4.1 The Virtual Channel Reception Function shall be used to decommutate fields of Transfer Frames of a Virtual Channel.

NOTE – There is an instance of the Virtual Channel Reception Function for each Virtual Channel.

4.3.4.2 The Virtual Channel Reception Function shall extract data units contained in the Data Field of the Transfer Frames, and deliver them to the user (i.e., the Packet Extraction Function, the Bitstream Extraction Function, or the VCA Service user).

4.3.4.3 If there is a user of the VC_OCF Service for a particular Virtual Channel, OCF_SDUs contained in the Operational Control Field of the Transfer Frames shall be extracted and delivered to the user.

4.3.4.4 If a gap in the Virtual Channel Frame Count is detected, a Loss Flag may (optionally) be delivered to the users.

4.3.4.5 An abstract model of the Virtual Channel Reception Function is illustrated in figure 4-15.

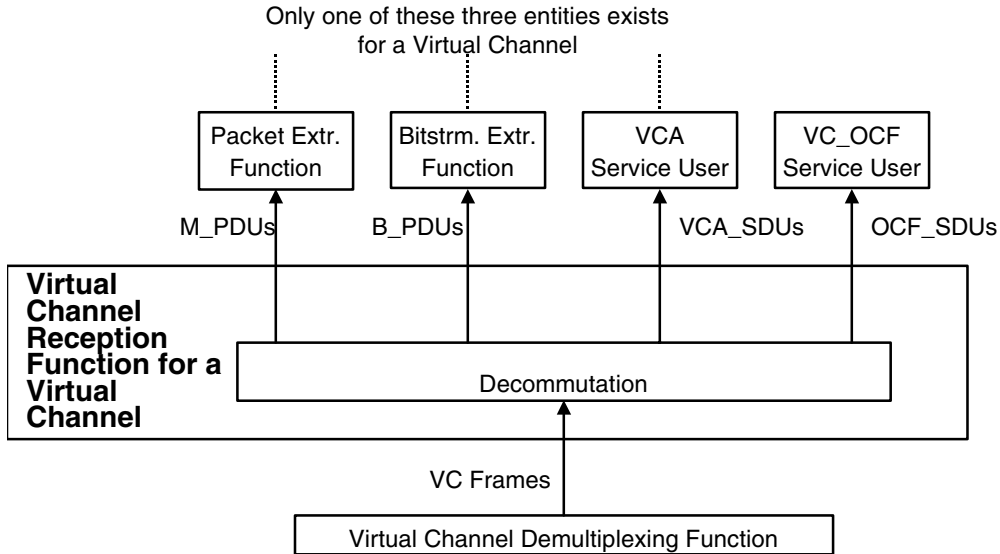

Figure 4-15: Abstract Model of Virtual Channel Reception Function

4.3.5 VIRTUAL CHANNEL DEMULTIPLEXING FUNCTION

4.3.5.1 The Virtual Channel Demultiplexing Function shall be used to demultiplex Transfer Frames of different Virtual Channels of a Master Channel.

NOTE – There is an instance of the Virtual Channel Demultiplexing Function for each Master Channel that has multiple Virtual Channels.

4.3.5.2 The Virtual Channel Demultiplexing Function shall examine the VCID in the incoming stream of Transfer Frames and route them to the instances of the Virtual Channel Reception Function and, if present, to the Virtual Channel Frame Service users.

4.3.5.3 If a gap in the Virtual Channel Frame Count is detected, a Loss Flag may (optionally) be delivered to the users.

NOTE – Idle Transfer Frames are discarded. Transfer Frames with an invalid VCID are also discarded.

4.3.5.4 An abstract model of the Virtual Channel Multiplexing Function is illustrated in figure 4-16.

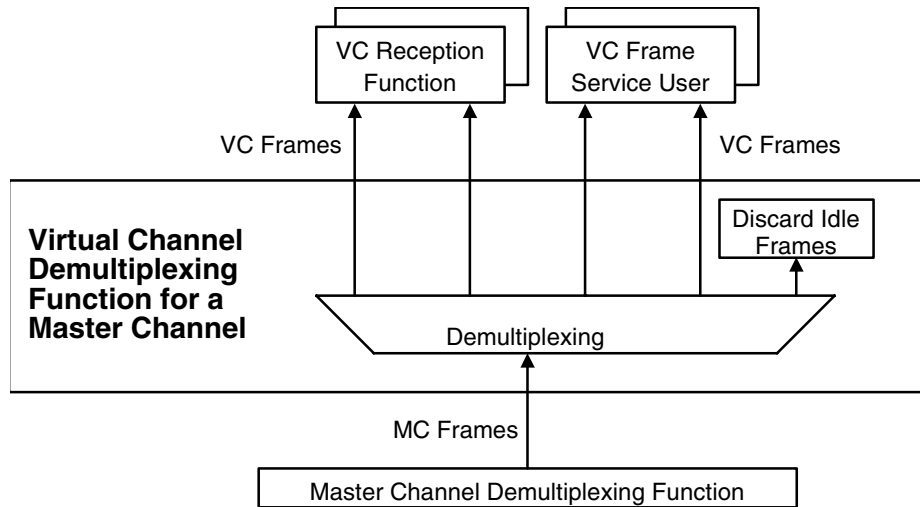

Figure 4-16: Abstract Model of Virtual Channel Demultiplexing Function

4.3.6 MASTER CHANNEL DEMULTIPLEXING FUNCTION

4.3.6.1 The Master Channel Demultiplexing Function shall be used to demultiplex Transfer Frames of different Master Channels of a Physical Channel.

NOTE – There is an instance of the Master Channel Demultiplexing Function for each Physical Channel that has multiple Master Channels.

4.3.6.2 The Master Channel Demultiplexing Function shall examine the MCID in the incoming stream of Transfer Frames and route them to the instances of the Virtual Channel Demultiplexing Function and, if present, to the Master Channel Frame Service users.

4.3.6.3 If frame loss is signaled by the underlying Channel Coding Sublayer, a Loss Flag may (optionally) be delivered to the users.

NOTE – Transfer Frames with an invalid MCID are discarded.

4.3.6.4 An abstract model of the Master Channel Demultiplexing Function is illustrated in figure 4-17.

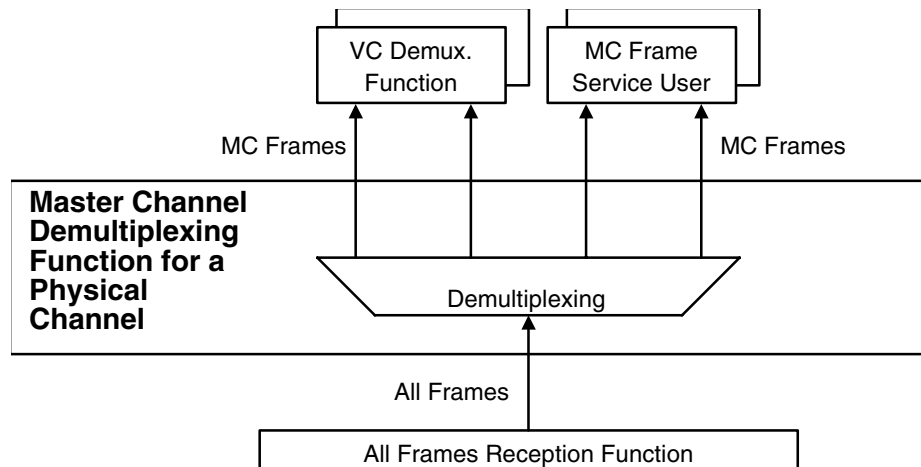

Figure 4-17: Abstract Model of Master Channel Demultiplexing Function

4.3.7 ALL FRAMES RECEPTION FUNCTION

4.3.7.1 The All Frames Reception Function shall be used to extract Insert service data units from Transfer Frames of a Physical Channel. It shall also be used to perform error control decoding defined by this Recommendation.

NOTE – There is an instance of the All Frames Reception Function for each Physical Channel.

4.3.7.2 If the Frame Header Error Control field is present in the Transfer Frame, then the All Frames Reception Function shall use the content of the Frame Header Error Control field to attempt to correct key elements of the Transfer Frame Primary Header.

NOTE – A Transfer Frame which contains detected and uncorrectable header errors is not required to be delivered in cross support situations.

4.3.7.3 If the Frame Error Control Field is present in the Transfer Frame, the All Frames Reception Function shall recompute the CRC value for the Transfer Frame and compare it to the content of the Frame Error Control field to determine if the Transfer Frame contains a detected error.

NOTE – A Transfer Frame which contains a detected error is not required to be delivered in cross support situations.

4.3.7.4 If the optional Insert Service is activated, the All Frames Reception Function shall extract the IN_SDUs from the Insert Zone of the incoming stream of Transfer Frames, regardless of their GVCID, and deliver them to the Insert Service user. If error protection of the IN_SDUs is not required, this function may be performed prior to decoding of Frame Error Control Field described above.

4.3.7.5 An abstract model of the All Frames Reception Function is illustrated in figure 4-18.

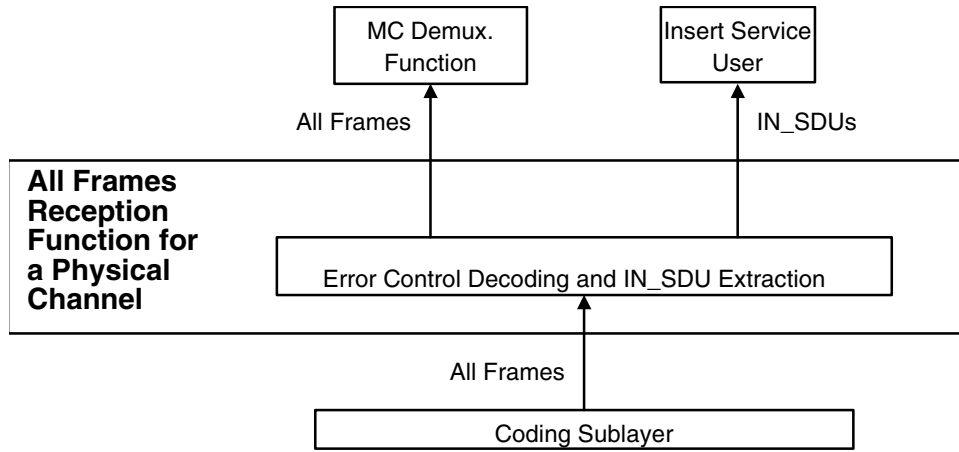

Figure 4-18: Abstract Model of All Frames Reception Function

5 MANAGED PARAMETERS

5.1 OVERVIEW OF MANAGED PARAMETERS

In order to conserve bandwidth on the space link, some parameters associated with the AOS Space Data Link Protocol are handled by management rather than by inline communications protocol. The managed parameters are those which tend to be static for long periods of time, and whose change generally signifies a major reconfiguration of the protocol entities associated with a particular mission. Through the use of a management system, management conveys the required information to the protocol entities.

In this section, the managed parameters used by the AOS Space Data Link Protocol are listed for each of the Channels and for Packet transfer. These parameters are defined in an abstract sense and are not intended to imply any particular implementation of a management system.

5.2 MANAGED PARAMETERS FOR A PHYSICAL CHANNEL

Table 5-1 lists the managed parameters associated with a Physical Channel.

Table 5-1: Managed Parameters for a Physical Channel

| Managed Parameter | Allowed Values |
|--|------------------|
| Physical Channel Name | Character String |
| Transfer Frame Length (octets) | Integer |
| Transfer Frame Version Number | 2 |
| Valid Spacecraft IDs | Set of Integers |
| MC Multiplexing Scheme | Mission Specific |
| Presence of Frame Header Error Control | Present, Absent |
| Presence of Insert Zone | Present, Absent |
| Insert Zone Length (octets) | Integer |
| Presence of Frame Error Control | Present, Absent |

5.3 MANAGED PARAMETERS FOR A MASTER CHANNEL

Table 5-2 lists the managed parameters associated with a Master Channel.

Table 5-2: Managed Parameters for a Master Channel

| Managed Parameter | Allowed Values |
|-------------------------------|--------------------------------|
| Transfer Frame Version Number | 2 |
| Spacecraft ID | Integer |
| Valid VCIDs | Set of Integers (from 0 to 63) |
| VC Multiplexing Scheme | Mission Specific |

5.4 MANAGED PARAMETERS FOR A VIRTUAL CHANNEL

Table 5-3 lists the managed parameters associated with a Virtual Channel.

Table 5-3: Managed Parameters for a Virtual Channel

| Managed Parameter | Allowed Values |
|-------------------------------|----------------------------------|
| Transfer Frame Version Number | 2 |
| Spacecraft ID | Integer |
| VCID | 0, 1, ..., 63 |
| Data Field Content | M_PDU, B_PDU, VCA_SDU, Idle Data |
| Presence of VC_OCF | Present, Absent |

5.5 MANAGED PARAMETERS FOR PACKET TRANSFER

Table 5-4 lists the managed parameters associated with a Virtual Channel used for the Packet Transfer Service.

Table 5-4: Managed Parameters for Packet Transfer

| Managed Parameter | Allowed Values |
|--------------------------------|-----------------|
| Transfer Frame Version Number | 2 |
| Spacecraft ID | Integer |
| VCID | 0, 1, ..., 63 |
| Valid Packet Version Numbers | Set of Integers |
| Maximum Packet Length (octets) | Integer |

ANNEX A**ACRONYMS**

(This annex **is not** part of the Recommendation)

This annex lists the acronyms used in this Recommendation.

| | |
|---------|---|
| AOS | Advanced Orbiting System |
| APID | Application Process Identifier |
| ARQ | Automatic Repeat Request |
| CCSDS | Consultative Committee for Space Data Systems |
| CLCW | Communications Link Control Word |
| COP | Communications Operation Procedure |
| FARM | Frame Acceptance and Reporting Mechanism |
| FDU | Frame Data Unit |
| FOP | Frame Operation Procedure |
| GMAP ID | Global Multiplexer Access Point Identifier |
| GVCID | Global Virtual Channel Identifier |
| MAP ID | Multiplexer Access Point Identifier |
| MAP | Multiplexer Access Point |
| MAPA | Multiplexer Access Point Access |
| MAPP | Multiplexer Access Point Packet |
| MC | Master Channel |
| MCF | Master Channel Frame |
| MCID | Master Channel Identifier |
| MSB | Most Significant Bit |
| OSI | Open Systems Interconnection |
| PVN | Packet Version Number |

| | |
|------|---|
| QoS | Quality of Service |
| SAP | Service Access Point |
| SCID | Spacecraft Identifier |
| SDU | Service Data Unit |
| SLAP | Space Link Automated Request for Transmission Procedure |
| TC | Telecommand |
| TFVN | Transfer Frame Version Number |
| VC | Virtual Channel |
| VCA | Virtual Channel Access |
| VCF | Virtual Channel Frame |
| VCID | Virtual Channel Identifier |
| VCP | Virtual Channel Packet |

ANNEX B

INFORMATIVE REFERENCES

(This annex **is not** part of the Recommendation)

- [B1] *Procedures Manual for the Consultative Committee for Space Data Systems*. CCSDS A00.0-Y-8. Yellow Book. Issue 8. Washington, D.C.: CCSDS, July 2002.
- [B2] *Advanced Orbiting Systems, Networks and Data Links: Architectural Specification*. Recommendation for Space Data Systems Standards, CCSDS 701.0-B-3. Blue Book. Issue 3. Washington, D.C.: CCSDS, June 2001.
- [B3] *Overview of Space Link Protocols*. Report Concerning Space Data System Standards, CCSDS 130.0-G-1. Green Book. Issue 1. Washington, D.C.: CCSDS, June 2001.
- [B4] *Cross Support Reference Model—Part 1: Space Link Extension Services*. Recommendation for Space Data System Standards, CCSDS 910.4-B-1. Blue Book. Issue 1. Washington, D.C.: CCSDS, May 1996.
- [B5] *TC Space Data Link Protocol*. Recommendation for Space Data System Standards, CCSDS 232.0-B-1. Blue Book. Issue 1. Washington, D.C.: CCSDS, September 2003.

NOTE – Normative references are listed in 1.7.

ANNEX C

CHANGES FROM REFERENCE [B2]

(This annex is **not** part of the Recommendation)

C1 GENERAL

This Recommendation was developed from the specification of the Data Link Layer portion of reference [B2], but a few technical specifications in reference [B2] have been changed in order to define all Space Data Link Protocols in a unified way. These technical changes are described in C.1. Also, some technical terms in reference [B2] have been changed in order to unify the terminology used in all the CCSDS Recommendations that define space link protocols, and to define this protocol as a general communications protocol. These terminology changes are listed in C.2.

C2 TECHNICAL CHANGES

C2.1 PACKETS WITH DIFFERENT VERSION NUMBERS

In reference [B2] only Version 1 Packets (i.e., CCSDS Packets) are allowed to be transferred as Packets. In this Recommendation, Packets with any Packet Version Number can be transferred as Packets as long as their Packet Version Number is authorized by CCSDS.

C2.2 MULTIPLEXING AND DEMULTIPLEXING OF PACKETS WITH DIFFERENT APPLICATION IDENTIFIERS

In reference [B2], Packets with different Application Identifiers (APIDs) are multiplexed and demultiplexed by the Data Link Layer. However, since the APID does not belong to the Data Link Layer, it is assumed in this Recommendation that Packets with different APIDs are multiplexed and demultiplexed by the Space Packet Protocol.

C2.3 MULTIPLEXING OF CODED AND NON-CODED TRANSFER FRAMES

Reference [B2] allows multiplexing of coded Transfer Frames (encoded with the Reed-Solomon code specified in reference [3]) with non-coded Transfer Frames on a Physical Channel. However, it has been discovered that in some circumstances the receiver cannot recover correct data if coded and non-coded Transfer Frames are mixed on the same Physical Channel. Therefore, in this Recommendation, multiplexing of coded Transfer Frames with non-coded Transfer Frames on a Physical Channel is not allowed, and every Transfer Frame must be of the same length on a given Physical Channel. For a similar reason, if the Frame Header Error Control is present, it must be present in every Transfer Frame on a Physical Channel. And if the Transfer Frame Error Control is present, it must be present in every Transfer Frame on a Physical Channel.

C2.4 INPUT TO THE VIRTUAL CHANNEL FRAME SERVICE

In reference [B2], the VCDU Service, which corresponds to the Virtual Channel Frame Service in this Recommendation, can accept Reed-Solomon coded Transfer Frames as input from the user. However, in order to specify the Channel Coding Sublayer independently of the services that are used to generate Transfer Frames, it is assumed in this Recommendation that Reed-Solomon encoding is performed after multiplexing of Transfer Frames. Therefore the Virtual Channel Frame Service of this Recommendation only accepts non-coded Transfer Frames from the user.

C2.5 MASTER CHANNEL FRAME SERVICE

In reference [B2], it is possible to multiplex Transfer Frames of different Master Channels on a physical channel, but no service is explicitly defined for transferring Transfer Frames of a Master Channel. This Recommendation specifies a service for transferring Transfer Frames of a Master Channel, which is called the Master Channel Frame Service.

C2.6 INTERNET AND ENCAPSULATION SERVICES

Reference [B2] specifies the Encapsulation Service and the Internet Service. However, these services are not included in this Recommendation because a proposal to define a new Encapsulation Service using a special Packet is being discussed within CCSDS. Once this proposal is accepted by CCSDS, the new Encapsulation Service will be defined as a supplement to this Recommendation.

C2.7 OPERATIONAL CONTROL FIELD SERVICES

A service for transferring data in the Operational Control Field (Virtual Channel Operational Control Field Service) has been added in order for the user to use this field.

C2.8 PARAMETERS OF SERVICE PRIMITIVES

In order to define the service primitives of all Space Data Link Protocols in a unified way, some parameters of some service primitives of reference [B2] have been changed slightly.

C2.9 SLAP

Reference [B2] contains a section on Space Link Automatic Repeat Request (ARQ) Procedure (SLAP). However, since no procedure is specified in reference [B2], SLAP is not included in this Recommendation.

C2.10 GRADES OF SERVICE

If SLAP is not used, the Grades of Service specified in reference [B2] only pertain to the selection of coding options. Since the coding options to be used with this Recommendation are specified in reference [3], the notion of Grades of Service is not used in this Recommendation.

C3 TERMINOLOGY CHANGES

Table C-1 lists the terms that have been changed from reference [B2].

Table C-1: Mapping of Terms That Have Been Redefined

| Terms Used in Reference [B2] | Terms Used in This Recommendation |
|---------------------------------------|--|
| Fill Packet | Idle Packet |
| Fill VCDU | Idle Frame |
| Isochronous Service | Periodic Service |
| LinkID | Physical Channel Name |
| Multiplexing Service | Packet Service |
| M_SDU | Packet |
| VCDU | (AOS) Transfer Frame |
| VCDU Data Unit Zone | Transfer Frame Data Field |
| VCDU Error Control Field | Frame Error Control Field |
| VCDU Header Error Control | Frame Header Error Control |
| VCDU Insert Zone | Transfer Frame Insert Zone |
| VCDU Primary Header | Transfer Frame Primary Header |
| VCDU Service | Virtual Channel Frame Service |
| VCDU Trailer | Transfer Frame Trailer |
| VCDU-ID | SCID + VCID |
| VC_PDU | (AOS) Transfer Frame |
| Virtual Channel Link Control Sublayer | (No Longer Used) |
| Virtual Channel Access Sublayer | (No Longer Used) |
| Virtual Channel Data Unit Counter | Virtual Channel Frame Count |