



CCSDS

The Consultative Committee for Space Data Systems

Report Concerning Space Data System Standards

CCSDS PROTOCOLS OVER DVB-S2—SUMMARY OF DEFINITION, IMPLEMENTATION, AND PERFORMANCE

INFORMATIONAL REPORT

CCSDS 130.12-G-1

GREEN BOOK

November 2016

Report Concerning Space Data System Standards

**CCSDS PROTOCOLS OVER
DVB-S2—SUMMARY OF
DEFINITION,
IMPLEMENTATION, AND
PERFORMANCE**

INFORMATIONAL REPORT

CCSDS 130.12-G-1

GREEN BOOK

November 2016

AUTHORITY

Issue:	Informational Report, Issue 1
Date:	November 2016
Location:	Washington, DC, USA

This document has been approved for publication by the Management Council of the Consultative Committee for Space Data Systems (CCSDS) and reflects the consensus of technical panel experts from CCSDS Member Agencies. The procedure for review and authorization of CCSDS Reports is detailed in *Organization and Processes for the Consultative Committee for Space Data Systems* (CCSDS A02.1-Y-4).

This document is published and maintained by:

CCSDS Secretariat
National Aeronautics and Space Administration
Washington, DC, USA
E-mail: secretariat@mailman.ccsds.org

FOREWORD

This document is a CCSDS Informational Report that contains background and explanatory material to support the CCSDS Recommended Standard for *CCSDS Space Link Protocols over ETSI DVB-S2 Standard* (reference [1]).

Through the process of normal evolution, it is expected that expansion, deletion, or modification of this document may occur. This Report is therefore subject to CCSDS document management and change control procedures, which are defined in *Organization and Processes for the Consultative Committee for Space Data Systems* (CCSDS A02.1-Y-4). Current versions of CCSDS documents are maintained at the CCSDS Web site:

<http://www.ccsds.org/>

Questions relating to the contents or status of this document should be sent to the CCSDS Secretariat at the e-mail address indicated on page i.

CCSDS PROTOCOLS OVER DVB-S2—SUMMARY OF DEFINITION, IMPLEMENTATION, AND PERFORMANCE

At time of publication, the active Member and Observer Agencies of the CCSDS were:

Member Agencies

- Agenzia Spaziale Italiana (ASI)/Italy.
- Canadian Space Agency (CSA)/Canada.
- Centre National d'Etudes Spatiales (CNES)/France.
- China National Space Administration (CNSA)/People's Republic of China.
- Deutsches Zentrum für Luft- und Raumfahrt (DLR)/Germany.
- European Space Agency (ESA)/Europe.
- Federal Space Agency (FSA)/Russian Federation.
- Instituto Nacional de Pesquisas Espaciais (INPE)/Brazil.
- Japan Aerospace Exploration Agency (JAXA)/Japan.
- National Aeronautics and Space Administration (NASA)/USA.
- UK Space Agency/United Kingdom.

Observer Agencies

- Austrian Space Agency (ASA)/Austria.
- Belgian Federal Science Policy Office (BFSP0)/Belgium.
- Central Research Institute of Machine Building (TsNIIMash)/Russian Federation.
- China Satellite Launch and Tracking Control General, Beijing Institute of Tracking and Telecommunications Technology (CLTC/BITTT)/China.
- Chinese Academy of Sciences (CAS)/China.
- Chinese Academy of Space Technology (CAST)/China.
- Commonwealth Scientific and Industrial Research Organization (CSIRO)/Australia.
- Danish National Space Center (DNSC)/Denmark.
- Departamento de Ciência e Tecnologia Aeroespacial (DCTA)/Brazil.
- Electronics and Telecommunications Research Institute (ETRI)/Korea.
- European Organization for the Exploitation of Meteorological Satellites (EUMETSAT)/Europe.
- European Telecommunications Satellite Organization (EUTELSAT)/Europe.
- Geo-Informatics and Space Technology Development Agency (GISTDA)/Thailand.
- Hellenic National Space Committee (HNSC)/Greece.
- Indian Space Research Organization (ISRO)/India.
- Institute of Space Research (IKI)/Russian Federation.
- KFKI Research Institute for Particle & Nuclear Physics (KFKI)/Hungary.
- Korea Aerospace Research Institute (KARI)/Korea.
- Ministry of Communications (MOC)/Israel.
- National Institute of Information and Communications Technology (NICT)/Japan.
- National Oceanic and Atmospheric Administration (NOAA)/USA.
- National Space Agency of the Republic of Kazakhstan (NSARK)/Kazakhstan.
- National Space Organization (NSPO)/Chinese Taipei.
- Naval Center for Space Technology (NCST)/USA.
- Scientific and Technological Research Council of Turkey (TUBITAK)/Turkey.
- South African National Space Agency (SANSA)/Republic of South Africa.
- Space and Upper Atmosphere Research Commission (SUPARCO)/Pakistan.
- Swedish Space Corporation (SSC)/Sweden.
- Swiss Space Office (SSO)/Switzerland.
- United States Geological Survey (USGS)/USA.

DOCUMENT CONTROL

Document	Title	Date	Status
CCSDS 130.12-G-1	CCSDS Protocols over DVB-S2— Summary of Definition, Implementation, and Performance, Informational Report, Issue 1	November 2016	Original issue

CONTENTS

<u>Section</u>	<u>Page</u>
1 INTRODUCTION	1-1
1.1 BACKGROUND	1-1
1.2 PURPOSE	1-1
1.3 SCOPE	1-1
1.4 ORGANIZATION	1-1
1.5 REFERENCES	1-1
2 RELATIVE ROLES OF CCSDS RECOMMENDED STANDARDS AND ETSI DVB-S2 STANDARDS	2-1
2.1 RATIONALE OF CCSDS PROTOCOLS OVER DVB-S2	2-1
2.2 CCSDS AND ETSI DVB-S2 VERSIONS	2-1
2.3 ETSI DVB-S2 USER GUIDELINES	2-2
2.4 CCSDS AND ETSI VCM / ACM MODE	2-2
3 DVB-S2 TERMINOLOGY AND PROTOCOL MANAGEMENT CONSIDERATIONS	3-1
3.1 INTRODUCTION	3-1
3.2 MODCOD AND TYPE	3-3
3.3 TYPICAL SIMPLIFIED CONFIGURATION	3-5
3.4 DUMMY PLFRAME	3-7
3.5 TRANSMISSION CLOSING	3-7
3.6 FRAME VALIDATION AND SLE-RAF SERVICE	3-8
4 IMPLEMENTATION AT THE INTERFACE BETWEEN CCSDS PROTOCOLS AND DVB-S2	4-1
4.1 INTRODUCTION	4-1
4.2 DVB-S2 BASEBAND HEADER SIMPLIFIED PROCESSING	4-1
4.3 EXAMPLE OF DATA INTERFACE AT THE TRANSMITTER INPUT TO WORK WITH DVB-S2 VCM/ACM	4-2
5 PERFORMANCE OF DVB-S2	5-1
5.1 INTRODUCTION	5-1
5.2 PERFORMANCE OVER AWGN CHANNEL	5-1
5.3 EXAMPLE OF PERFORMANCE WITH NON-LINEAR CHANNEL IMPAIRMENT	5-3

CONTENTS (continued)

<u>Section</u>	<u>Page</u>
5.4 EXAMPLE OF PERFORMANCE WITH STATIC PREDISTORTION OF POWER AMPLIFIER NON-LINEARITY	5-9
5.5 EXAMPLE OF DEMODULATION LOSS MEASURED ON AN HDRT RECEIVER	5-18
ANNEX A ACRONYMS AND TERMS	A-1
ANNEX B EXAMPLE OF SYSTEM PERFORMANCE WHEN USING DVB-S2 VCM AND ACM	B-1
ANNEX C POINTERS TO ETSI DVB-S2 USER GUIDELINES (REFERENCE [3]) SECTIONS OF INTEREST FOR TELEMETRY APPLICATIONS, AND TO OTHER TECHNICAL REPORTS OF INTEREST FOR RECEIVER IMPLEMENTATION	C-1

Figure

3-1 Illustration of Variable Conditions of Propagation	3-1
3-2 Illustration of Variable Conditions of Propagation with ACM	3-2
3-3 Functional Diagram of a Typical DVB-S2 Receiver	3-5
3-4 DVB-S2 Typical Receiver Performance with and without Pilot Insertion (16APSK 3/4, Short FECFRAME)	3-6
3-5 DVB-S2 Performance with Normal and Short FECFRAME	3-6
3-6 Stream Format while Transmitting CCSDS Transfer Frames Using DVB-S2 (Extract from reference [1])	3-8
4-1 Data-Pull Interface with Parallel LVDS Wires	4-3
4-2 On-Board Downloading Subsystem Functional Diagram with Data-Pull Interface ...	4-3
5-1 Performance over AWGN Channel—DVB-S2 Normal FECFRAME— Additional Results to ETSI User Guidelines	5-2
5-2 Performance over AWGN Channel—DVB-S2 Short FECFRAME— Additional Results to ETSI User Guidelines	5-2
5-3 Demodulation Loss Measurement Principle	5-3
5-4 Principle of Amplifier Operating Point Optimization	5-4
5-5 26 GHz Power Amplifier AM/AM and AM/PM Responses	5-5
5-6 Amplifier Operating Point Optimization for 16APSK 8/9	5-6
5-7 Performance with Constant $ IBO = 5.5$ dB	5-7
5-8 Amplifier Operating Point Optimization for 32APSK 8/9	5-8
5-9 AM/AM and AM/PM Responses of the 8 GHz TWTA	5-9
5-10 TD for 8PSK	5-12
5-11 TD as a Function of Γ and $\Delta\phi$ for a Fixed IBO	5-12
5-12 Optimal TD for 16APSK	5-13

CONTENTS (continued)

<u>Figure</u>	<u>Page</u>
5-13 Optimal TD for 32APSK.....	5-14
5-14 Illustration of ACPR Measurement.....	5-16
5-15 PSD at the PA Output for Various IBO.....	5-17
5-16 ACPR at the PA Output.....	5-18

Table

3-1 DVB-S2 Spectral Efficiency as a Function of MODCOD and TYPE	3-4
5-1 Optimal Operating Points, 16APSK, Roll-Off $\alpha = 0.2$	5-13
5-2 Optimal Operating Points, 16APSK, Roll-Off $\alpha = 0.35$	5-14
5-3 Optimal Operating Points, 32APSK, Roll-Off $\alpha = 0.2$	5-15
5-4 Optimal Operating Points, 32APSK, Roll-Off $\alpha = 0.35$	5-15
5-5 Example of Demodulation Loss Measured on a Modern Receiver.....	5-20

1 INTRODUCTION

1.1 BACKGROUND

The CCSDS Recommended Standard *CCSDS Space Link Protocols over ETSI DVB-S2 Standard* (reference [1]) is an adaptation profile describing how to use the ETSI DVB-S2 telecom standard (reference [2]) to transmit CCSDS Transfer Frames (references [5] and [6]) for telemetry purpose.

1.2 PURPOSE

This report has been developed to help missions interested in using the CCSDS Recommended Standard. It provides some useful material for engineers to define systems, or equipment manufacturers to develop products, according to the CCSDS Recommended Standard.

1.3 SCOPE

This document provides supporting and descriptive material only: it is not part of the CCSDS Recommended Standard. In the event of any conflict between the CCSDS Recommended Standard and the material presented herein, the CCSDS Recommended Standard is the prevailing specification.

1.4 ORGANIZATION

Section 2 presents the relative roles of the CCSDS Recommended Standard and the ETSI DVB-S2 standards.

Section 3 provides an introduction to DVB-S2 terminology and some protocol management considerations when using the CCSDS Recommended Standard.

Section 4 deals with implementation of the interface between CCSDS protocols and DVB-S2 when using the CCSDS Recommended Standard.

Section 5 provides some DVB-S2 performance material.

1.5 REFERENCES

The following publications are referenced in this document. At the time of publication, the editions indicated were valid. All publications are subject to revision, and users of this document are encouraged to investigate the possibility of applying the most recent editions of the publications indicated below. The CCSDS Secretariat maintains a register of currently valid CCSDS publications.

CCSDS PROTOCOLS OVER DVB-S2—SUMMARY OF DEFINITION,
IMPLEMENTATION, AND PERFORMANCE

- [1] *CCSDS Space Link Protocols over ETSI DVB-S2 Standard*. Issue 1. Recommendation for Space Data System Standards (Blue Book), CCSDS 131.3-B-1. Washington, D.C.: CCSDS, March 2013.
- [2] *Digital Video Broadcasting (DVB); Second Generation Framing Structure, Channel Coding and Modulation Systems for Broadcasting, Interactive Services, News Gathering and other Broadband Satellite Applications*. ETSI EN 302 307 V1.2.1 (2009-08). Sophia-Antipolis: ETSI, 2009.
- [3] *User Guidelines for the Second Generation System for Broadcasting, Interactive Services, News Gathering and Other Broadband Satellite Applications (DVB-S2)*. ETSI TR 102 376 V1.1.1 (2005-02). Sophia-Antipolis: ETSI, 2005.

NOTE – ETSI standards are available for free download at <http://www.etsi.org>.

- [4] *TM Synchronization and Channel Coding*. Issue 2. Recommendation for Space Data System Standards (Blue Book), CCSDS 131.0-B-2. Washington, D.C.: CCSDS, August 2011.
- [5] *TM Space Data Link Protocol*. Issue 2. Recommendation for Space Data System Standards (Blue Book), CCSDS 132.0-B-2. Washington, D.C.: CCSDS, September 2015.
- [6] *AOS Space Data Link Protocol*. Issue 3. Recommendation for Space Data System Standards (Blue Book), CCSDS 732.0-B-3. Washington, D.C.: CCSDS, September 2015.
- [7] *Space Link Extension—Return All Frames Service Specification*. Issue 4. Recommendation for Space Data System Standards (Blue Book), CCSDS 911.1-B-4. Washington, D.C.: CCSDS, August 2016.
- [8] J.-P. Millerioux, et al. “DVB-S2 Performance under Realistic Channel Conditions: CNES Simulations.” Presented at CCSDS Radio Frequency and Modulation Working Group meeting (October 2012, Cleveland, Ohio). SLS-RFM_12-11. 2012.
- [9] J.-P. Millerioux, et al. “CNES VCM in Lab Experiment for DVB-S2 High Data Rate Telemetry.” Presented at CCSDS Radio Frequency and Modulation Working Group meeting (April 2013, Bordeaux, France). SLS-CS_13-06. 2013.
- [10] J.-L. Issler and J.-P. Millerioux. “Use Cases of DVB-S2 for Telemetry.” Presented at CCSDS Radio Frequency and Modulation Working Group meeting (April 2014, Noordwijkerhout, The Netherlands). SLS RFM_14-04. 2014.
- [11] *8 Hints for Making and Interpreting EVM Measurements*. Application Note. Palo Alto, California: Agilent Technologies, 2005.
- [12] *Handbook of the Space Frequency Coordination Group*. Rev 7. Noordwijk, The Netherlands: SFCG, 2014.

- [13] G. Caire, G. Taricco, and E. Biglieri. “Bit-Interleaved Coded Modulation.” In *Proceedings of the 1997 IEEE International Symposium on Information Theory*, 96. New York: IEEE Conference Publications, 1997.
- [14] A. Fàbregas, A. Martinez, and G. Caire. “Bit-Interleaved Coded Modulation.” *Foundations and Trends in Communications and Information Theory* 5, no. 1–2 (January 2008): 1–153.
- [15] M. Bertinelli, et al. “ESA Advanced Coding and Modulation Performance under Realistic Channel Conditions.” Presented at CCSDS Radio Frequency and Modulation Working Group meeting (October 2009, Noordwijk, The Netherlands). SLS-RFM_09-09. 2009.
- [16] M. Alvarez-Diaz, R. Lopez-Valcarce, and C. Mosquera. “SNR Estimation for Multilevel Constellations Using Higher-Order Moments.” *IEEE Transactions on Signal Processing* 58, no. 3 (2010): 1515–1526.
- [17] S. Kim, et al. “SNR Estimation for DVB-S2 System.” In *Proceedings of the 25th AIAA International Communications Satellite Systems Conference (organized by APSCC) (10–13 April 2007, Seoul, South Korea)*. Reston, Virginia: AIAA, 2007.
- [18] S. Muller, et al. “A Novel LDPC Decoder for DVB-S2 IP.” In *Proceedings of the 2009 Design, Automation & Test in Europe Conference & Exhibition*, 1308–1313. Piscataway, New Jersey: IEEE Conference Publications, 2009.
- [19] A. Barre, et al. “A Polar-Based Demapper of 8PSK Demodulation for DVB-S2 Systems.” In *Proceedings of SiPS 2013*, 13–17. Piscataway, New Jersey: IEEE Conference Publications, 2013.
- [20] J. Lee and D. Yoon. “Soft-Decision Demapping Algorithm with Low Computational Complexity for Coded 4 + 12 APSK.” *International Journal of Satellite Communications and Networking* 31, no. 4 (July/August 2013): 103–109.
- [21] Jon Hamkins. “Performance of Low-Density Parity-Check Coded Modulation.” *IPN Progress Report* 42-184, February 2011 (February 15, 2011).
- [22] R. Pedone, et al. “Frame Synchronization in Frequency Uncertainty.” *IEEE Transactions on Communications* 58, no. 4 (2010): 1235–1246.
- [23] M. M. Mansour and N. R. Shanbhag. “High-Throughput LDPC Decoders.” *IEEE Transactions on Very Large Scale Integration (VLSI) Systems* 11, no. 6 (2003): 976–996.
- [24] M. Gomes, et al. “Flexible Parallel Architecture for DVB-S2 LDPC Decoders.” In *Proceedings of the IEEE Global Telecommunications*, 3265–3269. Piscataway, New Jersey: IEEE Conference Publications, 2007.

- [25] J. B. Sombrin. “Optimization Criteria for Power Amplifiers.” *International Journal of Microwave and Wireless Technologies* 3, no. 1 (February 2011): 35–45.
- [26] J. B. Sombrin. “On the Formal Identity of EVM and NPR Measurement Methods: Conditions for Identity of Error Vector Magnitude and Noise Power Ratio.” In *Proceedings of the 41st European Microwave Conference (EuMC)*, 337–340. Piscataway, New Jersey: IEEE Conference Publications, 2011.

2 RELATIVE ROLES OF CCSDS RECOMMENDED STANDARDS AND ETSI DVB-S2 STANDARDS

2.1 RATIONALE OF CCSDS PROTOCOLS OVER DVB-S2

The ETSI DVB-S2 (reference [2]) telecom standard was developed with the views of achieving high power efficiency and bandwidth efficiency, both criteria being also of very high value for telemetry applications.

The use of the ETSI DVB-S2 telecom standard for telemetry makes possible the use of generic Very High Scale Integrated Circuits (VHSIC) Hardware Description Language (VHDL) Intellectual Property (IP) cores, initially dedicated to the telecom market, for the development of telemetry equipment. The use of an already widely implemented standard simplifies the task of finding a transmitter or receiver for early compatibility tests. Regarding the ground part, some DVB-S2 receivers or Application Specific Integrated Circuits (ASICs) developed for the telecom mass market (and consequently with very competitive costs) could be reused for telemetry.

The DVB-S2 standard is consequently a technically efficient and cost-effective solution in particular for High Data Rate Telemetry (HDRT) applications, such as Earth Exploration Satellite Services (EESS) payload telemetry.

Actually, the DVB-S2 standard is already used for many telemetry applications (reference [10]), and the added value of the CCSDS Recommended Standard is mainly to provide a formalization of the interface between CCSDS and DVB-S2 for interoperability issues.

2.2 CCSDS AND ETSI DVB-S2 VERSIONS

The CCSDS Recommended Standard being an adaptation profile of the ETSI DVB-S2 telecom standard, it is worthwhile to consider the relationship between the CCSDS Recommended Standard and the different versions of the ETSI DVB-S2 telecom standard.

The different versions of the ETSI EN 302307 DVB-S2 standard are the following:

- V1.1.1, March 2005;
- V1.2.1, August 2009;
- V1.3.1, March 2013.

In 2014, the ETSI EN 302307 was split in two parts:

- Part 1: DVB-S2, reference ETSI EN 302307-1 V1.4.1 (July 2014);
- Part 2: DVB-S2 Extensions (DVB-S2X), reference ETSI EN 302307-2V1.1.1 (October 2014).

The CCSDS Recommended Standard (March 2013) is an adaptation profile referring to ETSI EN 302307 V1.2.1 (August 2009) (reference [2]). Because of the backward compatibility of the ETSI EN 302307 standard versions, the CCSDS Recommended Standard (March 2013) is also compatible with ETSI EN 302307 V1.3.1 (March 2013) and ETSI EN 302307-1 V1.4.1 (July 2014). Actually, all new versions of ETSI EN 302307 include the previous version with new options. Possible new versions of ETSI EN 302307 after 2014 are beyond the scope of this document.

2.3 ETSI DVB-S2 USER GUIDELINES

The CCSDS Recommended Standard being an adaptation profile of the ETSI DVB-S2 telecom standard (reference [2]), it is worth noting that some ETSI user guidelines (reference [3]) are available. The first release of these user guidelines is ETSI TR 102376 V1.1.1 (February 2005). An update to these guidelines with ETSI EN 302307-1 was proposed in 2015 (DVB Document A171-1, DVB-S2 Implementation Guidelines, March 2015), simultaneously with user guidelines for ETSI EN 302307-2 (DVB Document A171-2, DVB-S2X Implementation Guidelines, March 2015).¹

The technical content of these user guidelines is significant. They include in particular DVB-S2 reference performance over Additive White Gaussian Noise (AWGN) channel (see 5.2.2 of this document) and some results with power amplifier nonlinearity. Moreover, these user guidelines include substantial material concerning DVB-S2 VCM/ACM receivers and constitute an essential basis for people interested in detailed implementation of DVB-S2 receivers.

NOTE – For simplicity and consistency with DVB-S2 technical literature, the word ‘symbol’ is used throughout this document to indicate ‘channel symbol’, and E_s is used to indicate the energy per channel symbol.

References to guidelines sections that are possibly useful for the CCSDS Recommended Standard are listed in annex C of this document.

2.4 CCSDS AND ETSI VCM / ACM MODE

The ETSI DVB-S2 telecom standard includes a Constant Coding and Modulation (CCM) mode as well as Variable Coding and Modulation (VCM) mode and an Adaptive Coding and Modulation (ACM) mode. As an adaptation profile of the ETSI DVB-S2 telecom standard, the CCSDS Recommended Standard can accommodate DVB-S2 CCM as well as VCM and ACM modes.

Throughout this document, VCM and ACM should be understood as DVB-S2 VCM and DVB-S2 ACM.

¹ This document refers to the first (2005) release of ETSI User Guidelines (reference [3]).

3 DVB-S2 TERMINOLOGY AND PROTOCOL MANAGEMENT CONSIDERATIONS

3.1 INTRODUCTION

3.1.1 DVB-S2 VCM PRINCIPLE

It is well known that propagation conditions change during a Low Earth Orbit (LEO) satellite pass above an Earth station. Figure 3-1 shows the two main parameters that greatly influence the link budget and consequently the signal-to-noise ratio at the receiver input:

- the distance between the satellite and the Earth station (d_1 , d_2 , and d_3), depending on the elevation;
- the tropospheric propagation conditions (clouds, rain, ...).

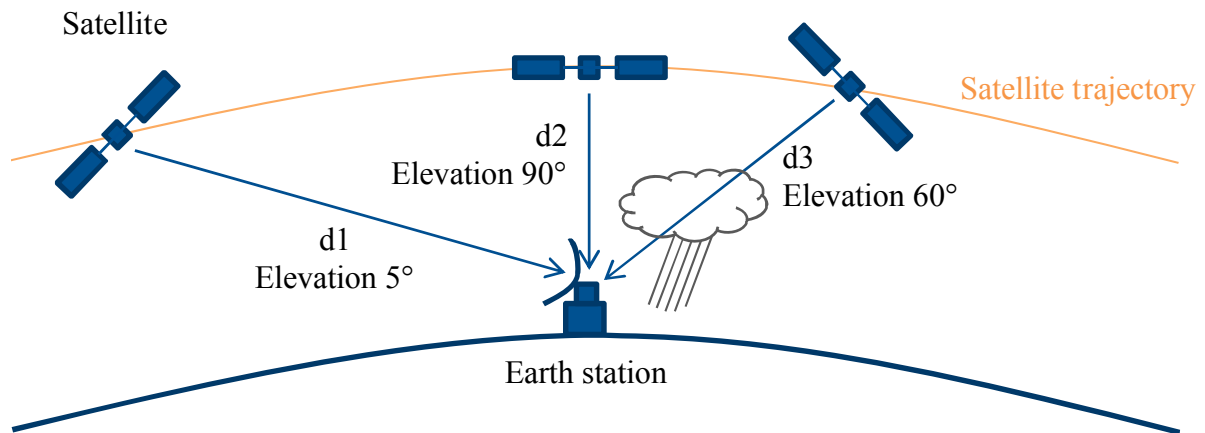

Figure 3-1: Illustration of Variable Conditions of Propagation

When the distance decreases with higher elevation ($d_2 < d_1$), the free-space loss also decreases and the link budget is improved. The achievable gain is significant: typically 12 dB for a satellite with 700 km orbit altitude. The better signal-to-noise ratio at the receiver allows use of more spectrally efficient modulation and/or coding rate.

This is where the VCM mode, available when using the DVB-S2 standard, fully benefits. The distance change can be predicted for each pass and the transmission can be planned to change the modulation and the coding rate when the link budget is more favorable to increase the useful bit rate. Thus the VCM mode allows maximizing the HDRT downloading throughput, keeping the same on-board power consumption.

As an example, following values of table 13 in reference [2], a gain of 12 dB on the link budget allows to go from Quaternary Phase Shift Keying (QPSK) with coding rate 3/4 ($E_s/N_o = 4$ dB) at 5-degree elevation to 32-ary Amplitude and Phase Shift Keying (32APSK) with coding rate 9/10 ($E_s/N_o = 16$ dB) at 90-degree elevation. The spectral efficiency of 32APSK 9/10 (4.45 bits/symbol) is three times the spectral efficiency of that from QPSK 3/4 (1.48 bits/symbol).

In practice, VCM will be used taking into account the change of the free-space loss (depending on the elevation) and also the change of the margin to cope with tropospheric propagation (also depending on the elevation).

3.1.2 DVB-S2 ACM PRINCIPLE

If the distance can be easily anticipated, some tropospheric propagation events may be more difficult to predict. The impact of these events on the link budget may be very significant, in particular when using the highest frequencies (such as Ka-band EESS). To cope with these events at the highest frequencies, the ACM mode can be considered.

This ACM mode consists in updating in quasi-real time the modulation and the coding rate to the best operating tuning, based on the received signal-to-noise ratio measurement by the receiver. Consequently, a quasi-real-time telecommand link to the satellite is required. The principle is illustrated in figure 3-2.

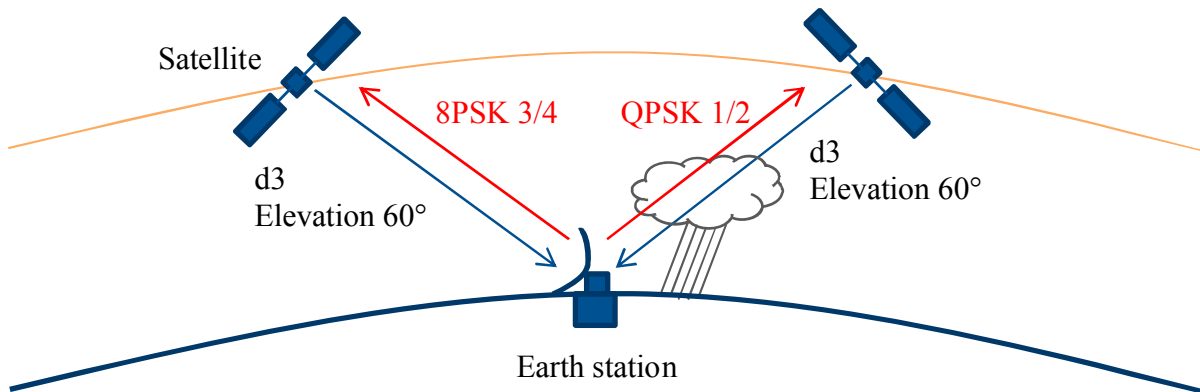

Figure 3-2: Illustration of Variable Conditions of Propagation with ACM

3.1.3 ABOUT THE USE OF DVB-S2 VCM AND ACM

Both VCM and ACM modes allow optimizing the on-board resources to offer the highest available useful bit rate according to the propagation conditions, thus maximizing the HDRT throughput.

The VCM mode can be typically considered with X-band EESS (8.025-8.4 GHz) transmissions, where the tropospheric losses remain low in the link budget.

The ACM mode can be typically considered for Ka-band EESS (25.5-27 GHz) transmissions, because of the atmospheric losses are highly variable with time.

Some examples of achievable system performance using DVB-S2 VCM or ACM are proposed in annex B.

In the ETSI DVB-S2 telecom standard (reference [2]), and consequently in the CCSDS Recommended Standard (reference [1]), the protocol is identical for VCM or ACM.

The difference between VCM and ACM is related to operation of the HDRT (which is beyond the scope of this document or of the scope of the CCSDS Recommended Standard).

3.1.4 OBJECTIVES OF SECTION 3

The objectives of section 3 are:

- to introduce the terminology used in the ETSI DVB-S2 telecom standard (reference [2]), in particular for VCM and ACM management (3.2);
- to present some technical material in support to the selection of CCSDS managed parameters in the CCSDS Recommended Standard (3.3);
- to present possible solutions to properly use the CCSDS Recommended Standard (3.4, 3.5, and 3.6).

3.2 MODCOD AND TYPE

The combination of a modulation and a coding rate is called a MODCOD as per DVB-S2 terminology. A MODCOD field can thus be coded using a decimal value between 0 and 28 (see reference [2] section 5.5.2.2), or 5 bits.

A TYPE field is added to the MODCOD field. This TYPE field is constituted of two bits. One bit indicates the Forward Error Correction Frame (FECFRAME) size (normal or short). The other bit indicates the pilot insertion status (ON or OFF).

When using DVB-S2 VCM or ACM modes, the MODCOD and TYPE can be changed by the transmitter on a frame-by-frame basis. Consequently, the MODCOD, the FECFRAME size and the pilot insertion status are variable managed parameters as per CCSDS terminology. Seven bits are required to encode these variable managed parameters.

These variable managed parameters are indicated in the Physical Layer Frame Header (PLHEADER) of the transmitted signal; it is consequently not necessary to provide them to the receiver working in VCM/ACM mode.

The useful data rate (defined as the data rate at the Channel Access Data Unit [CADU] level) depends on the MODCOD and the TYPE. It is equal to the product of the selected spectral efficiency listed in table 3-1 by the symbol rate used on the physical link.

Table 3-1: DVB-S2 Spectral Efficiency as a Function of MODCOD and TYPE

MODCOD	modulation	LDPC code identifier	spectral efficiency [bits/symbol]			
			short FECFRAME with pilots	short FECFRAME without pilots	normal FECFRAME with pilots	normal FECFRAME without pilots
1	QPSK	1/4	0.3575	0.3653	0.4786	0.4902
2	QPSK	1/3	0.6155	0.6291	0.6408	0.6564
3	QPSK	2/5	0.7446	0.7609	0.7706	0.7894
4	QPSK	1/2	0.8306	0.8488	0.9653	0.9889
5	QPSK	3/5	1.1317	1.1565	1.1600	1.1883
6	QPSK	2/3	1.2607	1.2884	1.2908	1.3223
7	QPSK	3/4	1.3897	1.4203	1.4521	1.4875
8	QPSK	4/5	1.4757	1.5082	1.5494	1.5872
9	QPSK	5/6	1.5618	1.5961	1.6153	1.6547
10	QPSK	8/9	1.6908	1.7280	1.7244	1.7665
11	QPSK	9/10	N/D	N/D	1.7460	1.7886
12	8PSK	3/5	1.6920	1.7253	1.7396	1.7800
13	8PSK	2/3	1.8850	1.9220	1.9357	1.9806
14	8PSK	3/4	2.0779	2.1188	2.1775	2.2281
15	8PSK	5/6	2.3351	2.3811	2.4223	2.4786
16	8PSK	8/9	2.5280	2.5778	2.5859	2.6460
17	8PSK	9/10	N/D	N/D	2.6184	2.6792
18	16APSK	2/3	2.5052	2.5488	2.5746	2.6372
19	16APSK	3/4	2.7616	2.8097	2.8963	2.9667
20	16APSK	4/5	2.9326	2.9836	3.0905	3.1656
21	16APSK	5/6	3.1035	3.1575	3.2219	3.3002
22	16APSK	8/9	3.3599	3.4184	3.4395	3.5231
23	16APSK	9/10	N/D	N/D	3.4827	3.5673
24	32APSK	3/4	3.4192	3.4931	3.6233	3.7033
25	32APSK	4/5	3.6308	3.7093	3.8662	3.9516
26	32APSK	5/6	3.8424	3.9255	4.0306	4.1195
27	32APSK	8/9	4.1599	4.2498	4.3029	4.3979
28	32APSK	9/10	N/D	N/D	4.3569	4.4530

3.3 TYPICAL SIMPLIFIED CONFIGURATION

3.3.1 GENERAL

For most of HDRT applications, there is no need to change the TYPE field. It is consequently suggested that these two bits be set to an unvarying value within a Mission Phase. Actually, this TYPE field is kept as a CCSDS variable managed parameter only for the sake of coherency between the CCSDS Recommended Standard and ETSI DVB-S2 telecom standard (reference [2]).

3.3.2 PILOT SYMBOLS INSERTION

Pilot symbols insertion in the transmitted signal may be useful to reinforce the robustness of the link. The functional diagram of a typical receiver is shown in figure 3-3. Pilots may be used for carrier phase interpolation by the receiver.

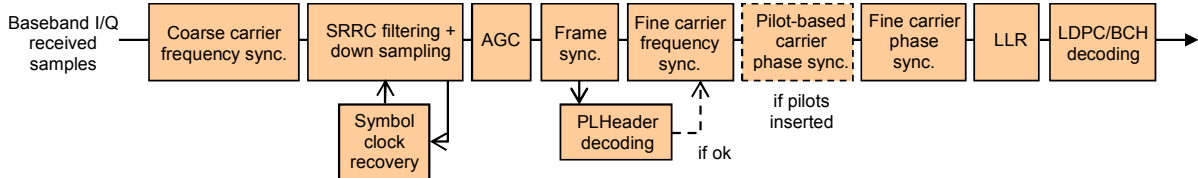

Figure 3-3: Functional Diagram of a Typical DVB-S2 Receiver

In the presence of phase noise, this carrier phase interpolation allows use of a Phase Lock Loop (PLL) for fine carrier phase recovery with a narrower loop bandwidth than without pilots. Hence degradation due to imperfect carrier recovery is reduced when using pilots. An example of comparison of DVB-S2 performance, with and without pilot insertion, and use of the typical DVB-S2 receiver in figure 3-3, is shown in figure 3-4 (where BIT designates the normalized loop bandwidth used for carrier phase recovery, and where reference stands for results with ideal synchronization).

Pilot symbols may also be useful to increase the robustness to the Doppler effects. Section B.2 of reference [3] points out that the DVB-S2 carrier recovery scheme (and thus the DVB-S2 pilot symbols structure) was conceived to cope with a frequency offset up to 5 MHz and with a frequency ramp up to 30 KHz/s (the target being telecom symbol rates, typically from 10 to 30 Mbauds). Maximum Doppler shift and Doppler rate values in LEO are typically less than 660 KHz and 17 KHz/s (worst case of a satellite with height 300 km and carrier frequency 26 GHz). Moreover, data rates considered for HDRT of LEO satellites are usually higher than those considered for telecoms (typically by a ratio from 5 to 20), so frequency recovery is easier for HDRT applications (thanks to this higher symbol rate). Therefore it appears quite feasible to cope with Doppler effects in the context of the use of references [1] and [2].

Finally, since the cost of pilot symbols in terms of power/bandwidth efficiency is negligible, it is advised to consider the use of pilots, in particular in case of lack of fine technical evaluations.

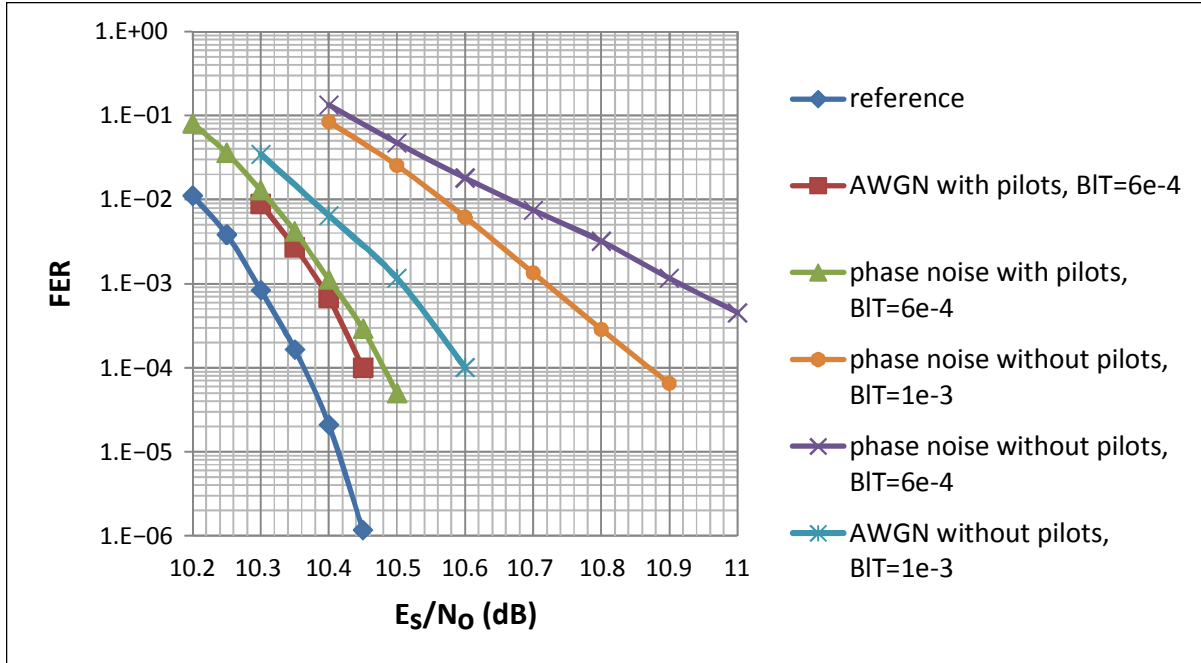

Figure 3-4: DVB-S2 Typical Receiver Performance with and without Pilot Insertion (16APSK 3/4, Short FECFRAME)

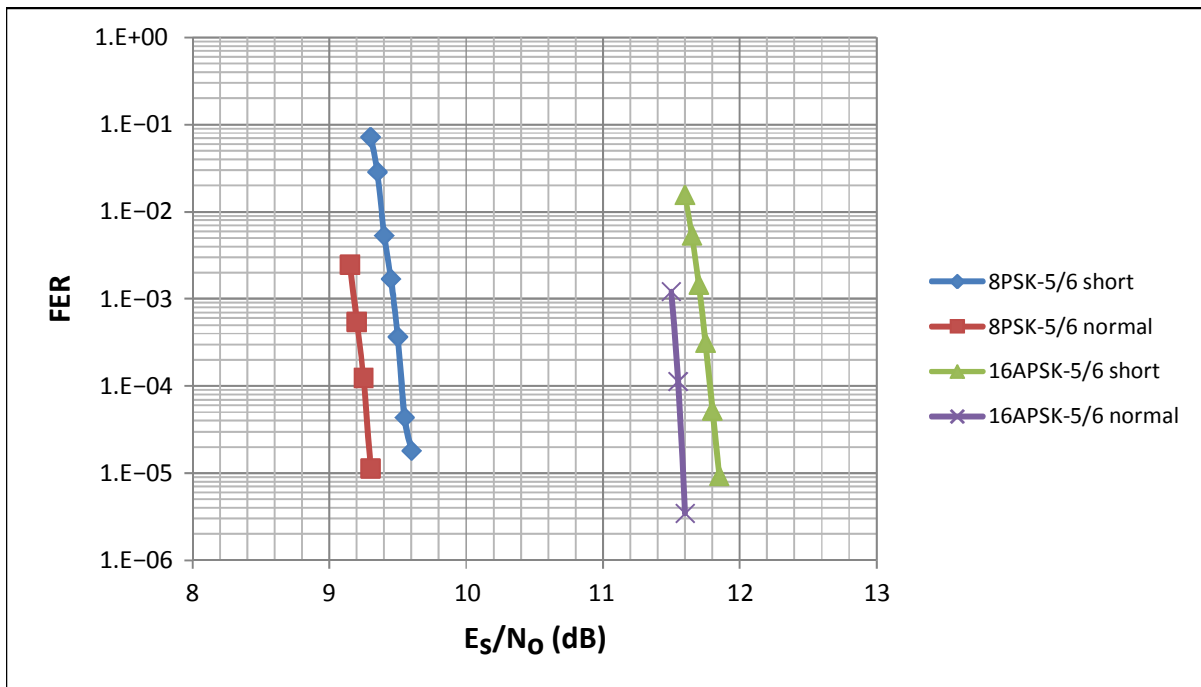

Figure 3-5: DVB-S2 Performance with Normal and Short FECFRAME

3.3.3 NORMAL FECFRAME

The Bits Interleaved Coded Modulation (BICM) scheme used in the DVB-S2 standard is a pragmatic way to achieve performance close to the AWGN channel capacity, even for High Order Modulation, with dissociation of demodulation step and decoding step (by computing Log-Likelihood Ratio) to reduce receiver complexity (see references [13] and [14]).

According to information theory, a long frame allows a more efficient Forward Error Correction (FEC). Hence, in the DVB-S2 standard, the normal FECFRAME is more efficient than the short FECFRAME from a power/bandwidth trade-off point of view. A comparison of DVB-S2 performance with normal and short FECFRAME is shown in figure 3-5. It is consequently advised to use the normal FECFRAME whenever possible.

3.4 DUMMY PLFRAME

The DVB-S2 standard allows inserting a so-called Dummy Physical Layer Frame (PLFRAME) in the transmitted signal. This Dummy PLFRAME does not convey any information, and is identified and suppressed by all DVB-S2 receivers (i.e., it does not appear in the data flow at the receiver output).

For some applications or some technical implementation solutions, it can be more convenient to use this Dummy PLFRAME rather than CCSDS Only Idle Data (OID) Transfer Frames encapsulated in DVB-S2. Actually, the reception of a Dummy PLFRAME cannot generate any error or warning at the receiving end (since the Dummy PLFRAME is not decoded) whereas the erroneous reception of an OID Transfer Frame generates errors at the DVB-S2 decoder level (BCH code allowing integrity check) and at the Transfer Frame level (CRC). Typical utilizations of the Dummy PLFRAME include:

- opening of the link at the beginning of a satellite pass;
- maintenance of the link continuity when downloading is stopped for link budget reasons;
- maintenance of the link continuity when data are not available at the DVB-S2 transmitter input (which is not possible with a system fully following the CCSDS standards, but can happen in practice);
- stand-by mode of the transmitter.

This Dummy PLFRAME is referenced as the MODCOD 0. The associated spectral efficiency is 0.

3.5 TRANSMISSION CLOSING

As described in reference [1], the encapsulation of CCSDS Transfer Frames in DVB-S2 frames is asynchronous (and the DVB-S2 padding is not used). Consequently, the transmission of a non-useful data sequence (by the DVB-S2 transmitter itself, or by the data

source feeding the transmitter) is required to flush the data in the DVB-S2 transmitter buffer and properly close the download without loss of useful data. The required minimum length of the data sequence of non-useful bits depends on the current MODCOD and TYPE. The worst case is obtained with the coding rate 9/10 and normal FECFRAME, and is (58192–80) bits.

CCSDS OID Transfer Frames can be used for this non-useful data sequence rather than a pseudo-random data sequence. It allows maintaining the flow of the CADU stream at the receiver side during a temporary interruption of data transmission (see figure 3-6). It is useful when the transmission is not fully predicted on-ground (such as when using ACM). The minimum number of required OID Transfer Frames depends on the current MODCOD and TYPE and on the CCSDS Transfer Frame length. A worst case is obtained considering the coding rate 9/10 with normal FECFRAME. The number of OID Transfer Frames required in this worst case is at least $(58192-80)/(\text{CCSDS Transfer Frame Length in bits} + 32 \text{ bits of Attached Synchronization Marker [ASM]})$.

NOTE – It is suggested to choose the CCSDS Transfer Frame Length equal to (or close to) the maximal value of 2048 octets to minimize the overhead loss. When using this CCSDS Transfer Frame Length and DVB-S2 normal FECFRAME size, 4 OID Transfer Frames are required to close the transmission properly.

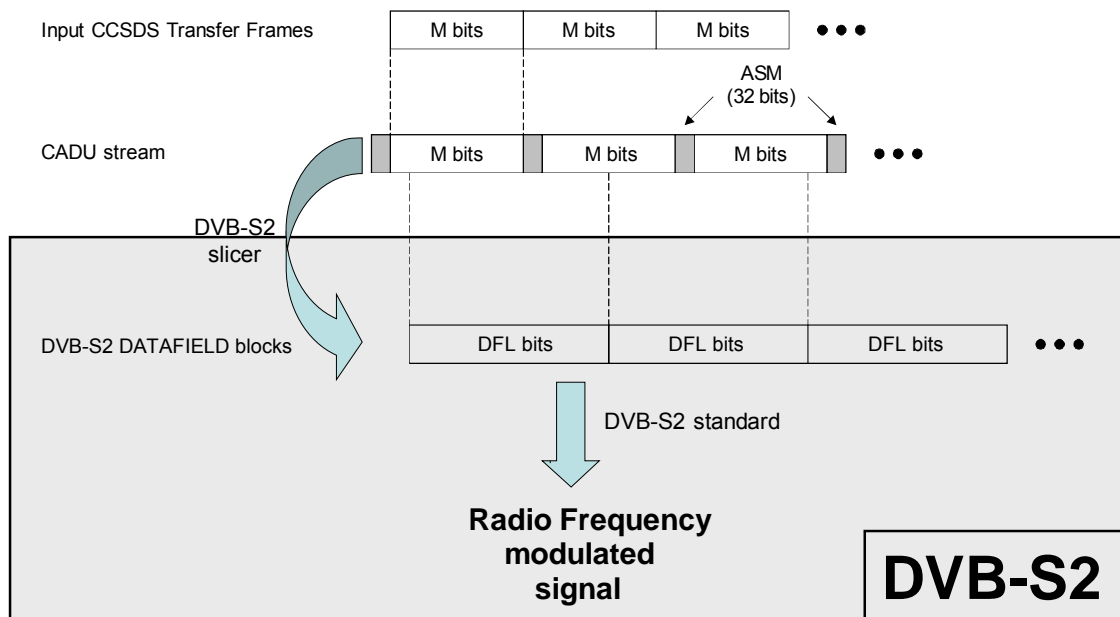

Figure 3-6: Stream Format while Transmitting CCSDS Transfer Frames Using DVB-S2²

3.6 FRAME VALIDATION AND SLE-RAF SERVICE

The Space Link Extension Return All Frames (SLE-RAF) service is defined in reference [7]. It allows different possible **requested-frame-quality** parameter values: ‘good frames only’, ‘erred frames only’, and ‘all frames’ (reference [7] subsection 3.4.2.7).

² From reference [1].

Therefore a **delivered-frame-quality** ('good', 'erred' or 'undetermined') is established by the receiver on a frame-by-frame basis (reference [7] subsection 3.6.2.6.1) before delivery to the SLE-RAF service.

When considering the use of the CCSDS Recommended Standard and SLE-RAF (reference [7]), the Frame Error Control Field (see reference [1], subsection 5.2.1.2) is used for Frame Validation (see reference [1], subsection 2.2.5): a received Transfer Frame can be marked 'good' if it passes the CRC, or 'erred' if it does not pass the CRC.

When the **requested-frame-quality** parameter value of the SLE-RAF service is set to 'erred frames only' or 'all frames', a receiver following the CCSDS Recommended Standard (including the DVB-S2 receiver, the CADU synchronization, and Frame Validation) will deliver an 'erred' Transfer Frame with the same length as a 'good' Transfer Frame (reference [7] subsection 3.6.2.8.b).

It is worth noting that the DVB-S2 receiver checks the reliability of received FECFRAMEs (thanks to the BCH code—reference [2]), and therefore may be set up to discard or not discard incorrectly decoded FECFRAMEs:

- If the DVB-S2 receiver is set up to discard incorrectly decoded FECFRAMEs, the CADU stream will show some discontinuities, and some 'erred' frames will not be deliverable to the SLE-RAF service.
- If the DVB-S2 receiver is set up to not discard incorrectly decoded FECFRAMEs, the DVB-S2 receiver may output the assumed content of the DVB-S2 DATAFIELD (reference [2]) even for incorrectly decoded FECFRAMEs. The CADU stream will not show discontinuity. 'Erred' frames will be detected by the CRC, and, if required, delivered to the SLE-RAF service.

4 IMPLEMENTATION AT THE INTERFACE BETWEEN CCSDS PROTOCOLS AND DVB-S2

4.1 INTRODUCTION

The CCSDS Recommended Standard being an adaptation profile of the ETSI DVB-S2 telecom standard (reference [2]), the interface between CCSDS protocols and DVB-S2 is of particular interest.

All DVB-S2 telecom development can be considered for application to the CCSDS case (see 2.1), the CCSDS Recommended standard (reference [1]) ensuring proper and full interface compatibility between the CCSDS layers and the DVB-S2 standard (reference [2]). However, some specific HDRT implementations (possibly not including DVB-S2 options useless for the CCSDS Recommended Standard) may be considered to reduce implementation complexity at the interface between CCSDS protocols and DVB-S2. Subsection 4.2 deals with such a simplified implementation.

Considering now on-board data interfaces (typically between a mass memory and a transmitter), the classical ‘data-push’ interface, originally conceived for low-data-rate telemetry, does not seem particularly suited to work with variable useful data rates with VCM/ACM. Hence a possible solution for a VCM/ACM interface at the transmitter input is presented in 4.3.

4.2 DVB-S2 BASEBAND HEADER SIMPLIFIED PROCESSING

In the DVB-S2 standard, a BaseBand Header (BBHEADER) of 10 octets length is inserted at the beginning of each BaseBand Frame (BBFRAME). This BBHEADER includes some signaling related to the DVB-S2 standard. The BBHEADER structure is fully described in reference [2] section 5.1.6.

Actually, this signaling is not essential for a telemetry transmission. However, this BBHEADER must not be bypassed in a transmitter, according to the CCSDS Recommended Standard (reference [1]), for the sake of full DVB-S2 compatibility (to ensure the possible reuse of commercial telecom receivers). Moreover, the complexity added by this BBHEADER insertion is very limited (for the transmitter and the receiver), as explained hereunder.

According to the CCSDS Recommended Standard, most of the BBHEADER content is fixed, in particular during a mission phase. Indeed, during a mission phase, the potentially variable content is limited to the DVB-S2 DATA FIELD LENGTH (DFL) and the DVB-S2 CRC-8 (depending on the DFL value). According to subsection 4.2.3 of the CCSDS Recommended Standard, this DFL depends only on the FECFRAME size ($DFL = K_{\text{bch}} - 80$ bits) and the coding rate.

Actually, these two parameters (FECFRAME size and coding rate) are required by the receiver before FEC decoding, justifying that they are still indicated in the DVB-S2

PLHEADER. Additional content of the BBHEADER with respect to the PLHEADER is limited to the transmission mode (CCM or VCM/ACM) and the transmitted roll-off.

Thus the telemetry receiver, designed according to reference [1], can bypass the BBHEADER interpretation because, on one hand, it knows the transmission roll-off or uses adaptive equalization, and, on the other hand, it knows the transmission mode or always assumes a VCM/ACM mode.

Concerning the DVB-S2 transmitter designed according to reference [1]:

- the BBHEADER does not change in CCM mode;
- the BBHEADER changes only with the FECFRAME size and coding rate during a mission phase with VCM/ACM mode.

It can be pointed-out that the 10th octet of the BBHEADER is a CRC upon the first 9 octets of the BBHEADER.

A possible implementation scheme can be based on a tabulated function to compute the BBHEADER:

- input parameters—transmission mode (CCM or VCM/ACM), roll-off, FECFRAME size, coding rate;
- output parameters—possibly varying octets of the BBHEADER:
 - Octet 1/10 (MATYPE),
 - Octets 5/10 and 6/10 ($DFL=K_{bch}-80$),
 - Octet 10/10 (CRC-8).

The other BBHEADER octets can be set to '0'.

NOTE – This tabulated function can be further simplified for a given mission by considering unvarying transmission mode, roll-off, and FECFRAME size as proposed in 3.3.

4.3 EXAMPLE OF DATA INTERFACE AT THE TRANSMITTER INPUT TO WORK WITH DVB-S2 VCM/ACM

It should be recalled that the DVB-S2 standard, being originally designed for telecom applications, implies a time-unvarying symbol rate. Similarly, in an HDRT context, the symbol rate does not change during a mission phase. When using VCM or ACM transmission mode, the required data rate at the DVB-S2 transmitter input (input CADU stream data rate) depends on the MODCOD. Required input data rates can be derived from the symbol rate and the spectral efficiencies in table 3-1.

A convenient solution to cope with this time-varying data rate is to use a ‘data-pull’ interface. A typical implementation of this data interface using parallel Low Voltage Differential Signaling (LVDS) wires, and used in reference [9], is shown in figure 4-1. A functional diagram of the on-board downloading subsystem is shown in figure 4-2.

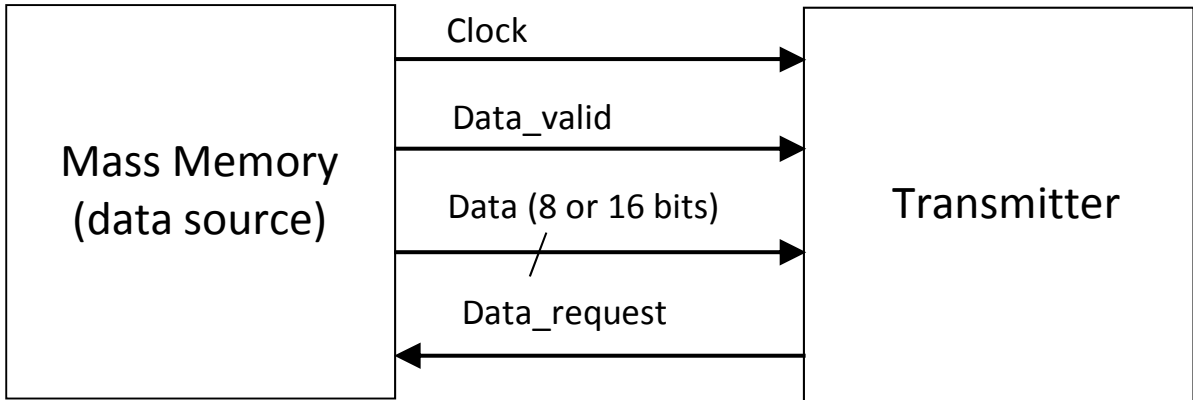

Figure 4-1: Data-Pull Interface with Parallel LVDS Wires

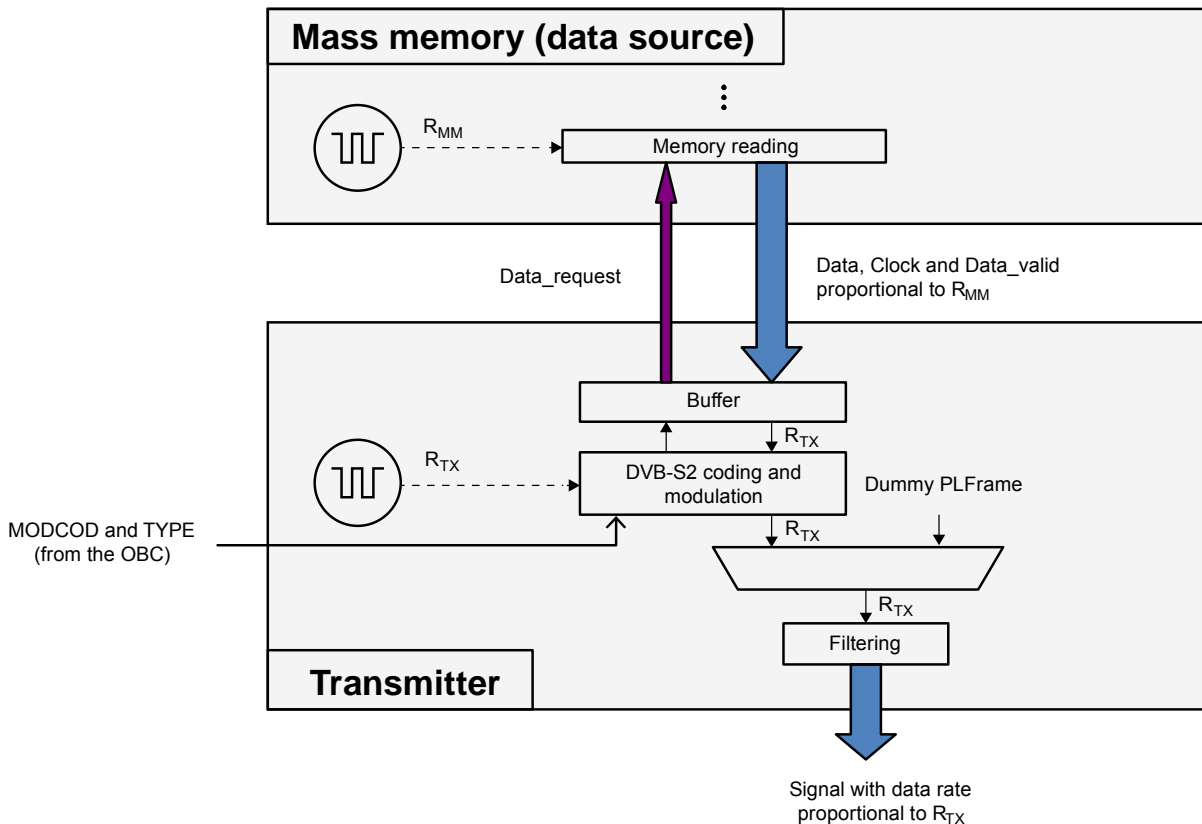

Figure 4-2: On-Board Downloading Subsystem Functional Diagram with Data-Pull Interface

The data source at the transmitter input is here mass memory. The master equipment is the transmitter and the slave equipment is the data source. The transmitted symbol rate (and consequently the transmitted data rate) is proportional to the internal clock of the transmitter. The data rate at the interface between the data source and the transmitter is proportional to the internal clock of the data source. The transmitter has an internal buffer at its input to store data before processing (i.e., coding, modulation, and filtering).

At the beginning of a downloading sequence, the transmitter sets the ‘data_request’ signal to ‘1’, and thus the data source begins to send data to the transmitter. When using VCM/ACM modes, these data must be sent with a data rate higher than the maximum data rate achievable by the transmitter. Consequently, the buffer is filled. When the buffer filling reaches a maximum value, the ‘data_request’ signal is set to ‘0’, the data source stops sending data to the transmitter, and the buffer is dumped. Then, when the buffer filling reaches a minimum value, it sets the ‘data_request’ signal to ‘1’, and so on. A proper choice of the buffer size and of the minimum and maximum filling values (taking into account response times of the data source and the transmitter) is required. This system is then able to cope with any transmitter data-rate change.

The ‘data_valid’ signal (equal to ‘1’ when some data are transferred from the data source to the transmitter, otherwise equal to ‘0’) is used by the transmitter to detect when data are received.

This ‘data-pull’ interface would allow exchanging an unframed stream of data between the data source and the transmitter. However, it is rather suggested to exchange an entire CADU at the interface between the data source and the transmitter.

The ‘data-pull’ concept can be used with a ‘wizard link’ or a High Speed Serial Link (HSSL) for the data transfer between the data source and the transmitter. In such a case, the physical electric interface of the ‘data_request’ signal can be different from the data interface.

If a device is inserted between the data source and the transmitter (for example a ciphering device), it may include a buffer at its input and transmit the ‘data_request’ signal from the transmitter to the data source. By doing so, the system is able to work with VCM/ACM.

Finally, it can be pointed out that the use of a stuffing mechanism (for example using the DVB-S2 Dummy PLFRAME or an OID Transfer Frame) appears natural to secure the link continuity when using a ‘data-pull’ interface.

5 PERFORMANCE OF DVB-S2

5.1 INTRODUCTION

The objective of this section is to present a synthesis of DVB-S2 performance useful for HDRT engineers.

- Subsection 5.2 provides exhaustive references and results for theoretical DVB-S2 performance over AWGN channel.
- Subsection 5.3 provides examples of DVB-S2 performance in an HDRT non-linear (due to power amplifier) channel, using software simulations with a fully emulated receiver and FECFRAME Error Rate (FER) measurements.
- Subsection 5.4 provides exhaustive DVB-S2 performance in an HDRT non-linear (due to power amplifier) channel, using software simulations with a simplified receiver and Error Vector Magnitude (EVM) measurements (allowing a considerable diminution of the simulation time with respect to 5.3). This subsection also provides results concerning Power Spectrum Density (PSD).
- Subsection 5.5 provides some hardware results from recent measurements on HDRT equipment.

5.2 PERFORMANCE OVER AWGN CHANNEL

5.2.1 INTRODUCTION

The objective of this subsection is to provide references and results for theoretical performances of DVB-S2 over AWGN channel.

5.2.2 NORMAL FECFRAME

Some performances can be found in ETSI user guidelines (reference [3]), section A.3, pages 66–67, in terms of MPEG Packet Error Rate (PER). Actually, simulations show that FER and PER values are very close. Moreover, since the curve slopes are very steep, the difference in terms of E_s/N_o is negligible (<0.05 dB).

Simulation results for MODCOD missing in reference [3] are presented in figure 5-1.

5.2.3 SHORT FECFRAME

Some performances can be found in reference [3], section A.3, page 68.

Simulation results for MODCODs missing in reference [3] are presented in figure 5-2.

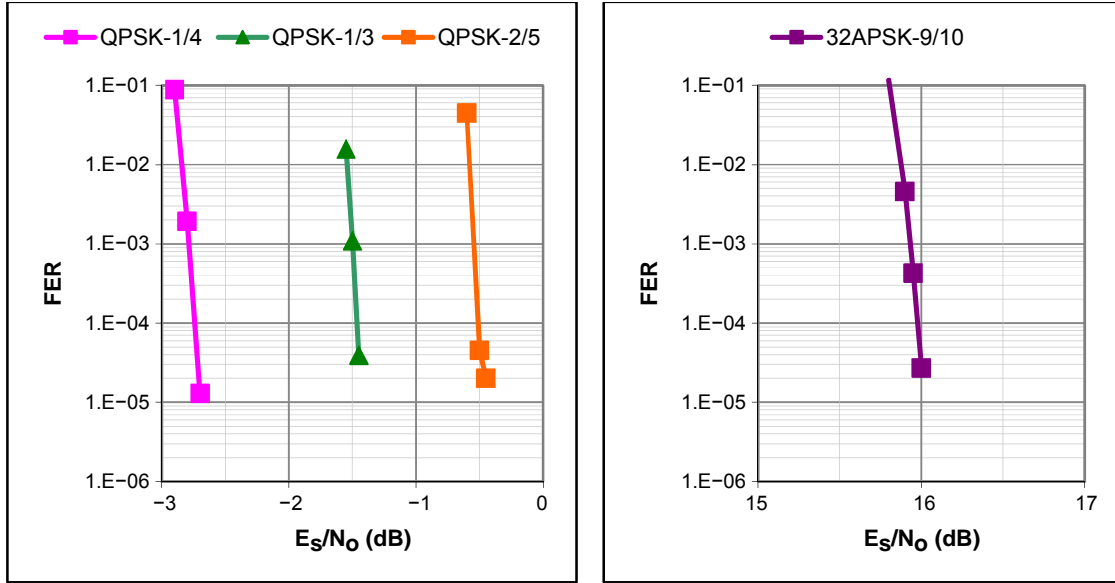

**Figure 5-1: Performance over AWGN Channel—DVB-S2 Normal FECFRAME—
Additional Results to ETSI User Guidelines**

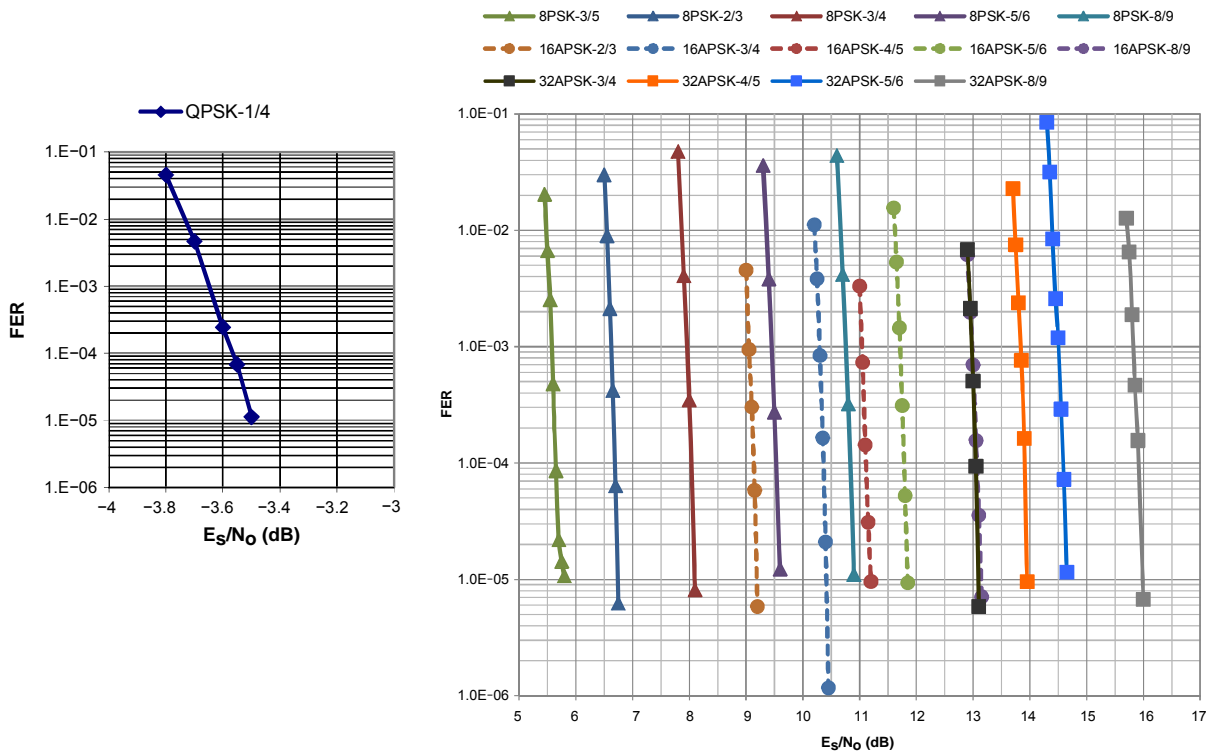

**Figure 5-2: Performance over AWGN Channel—DVB-S2 Short FECFRAME—
Additional Results to ETSI User Guidelines**

5.3 EXAMPLE OF PERFORMANCE WITH NON-LINEAR CHANNEL IMPAIRMENT

5.3.1 INTRODUCTION

The objectives of this subsection are:

- to present simulation results illustrating the behavior of DVB-S2 over a non-linear channel;
- to point out the interest of adapting the amplifier operating point according to the used MODCOD.

Channel impairment is thus limited in this subsection to the non-linear impairment without memory from the power amplifier.

5.3.2 PRINCIPLE OF AMPLIFIER OPERATING POINT OPTIMIZATION

To optimize the amplifier operating point for a given MODCOD, two effects have to be considered.

For a given Output Back-Off (OBO), the available RF power at the amplifier output is reduced with respect to the RF power available at saturation. Thus a back-off implies a loss over the link budget, and it appears interesting to reduce this OBO.

However, the non-linear effect of the power amplifier induces a demodulation loss. This degradation increases when reducing the OBO, as shown in figure 5-3.

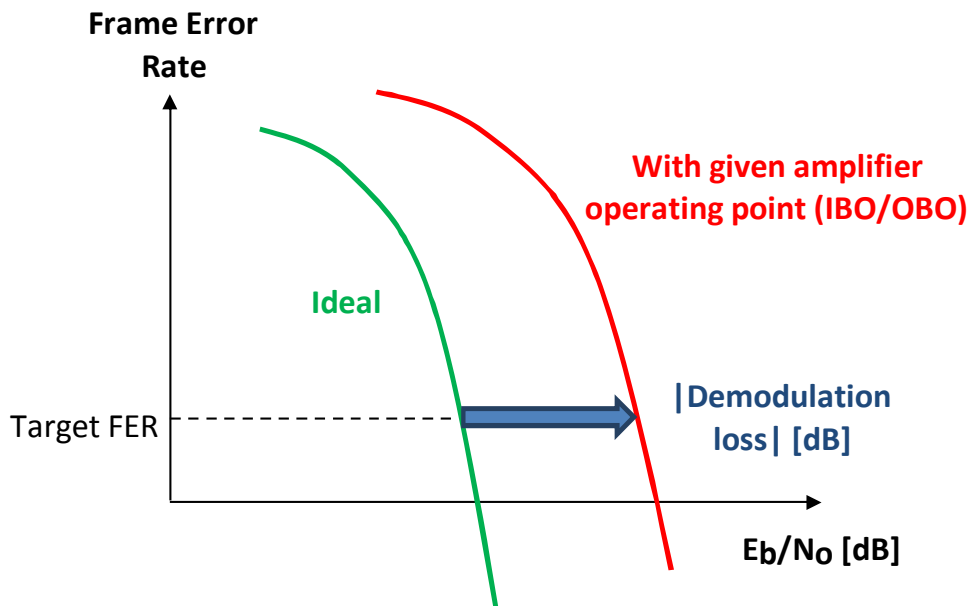

Figure 5-3: Demodulation Loss Measurement Principle

Finally, an optimum OBO can be found—for a given MODCOD—as shown in figure 5-4.

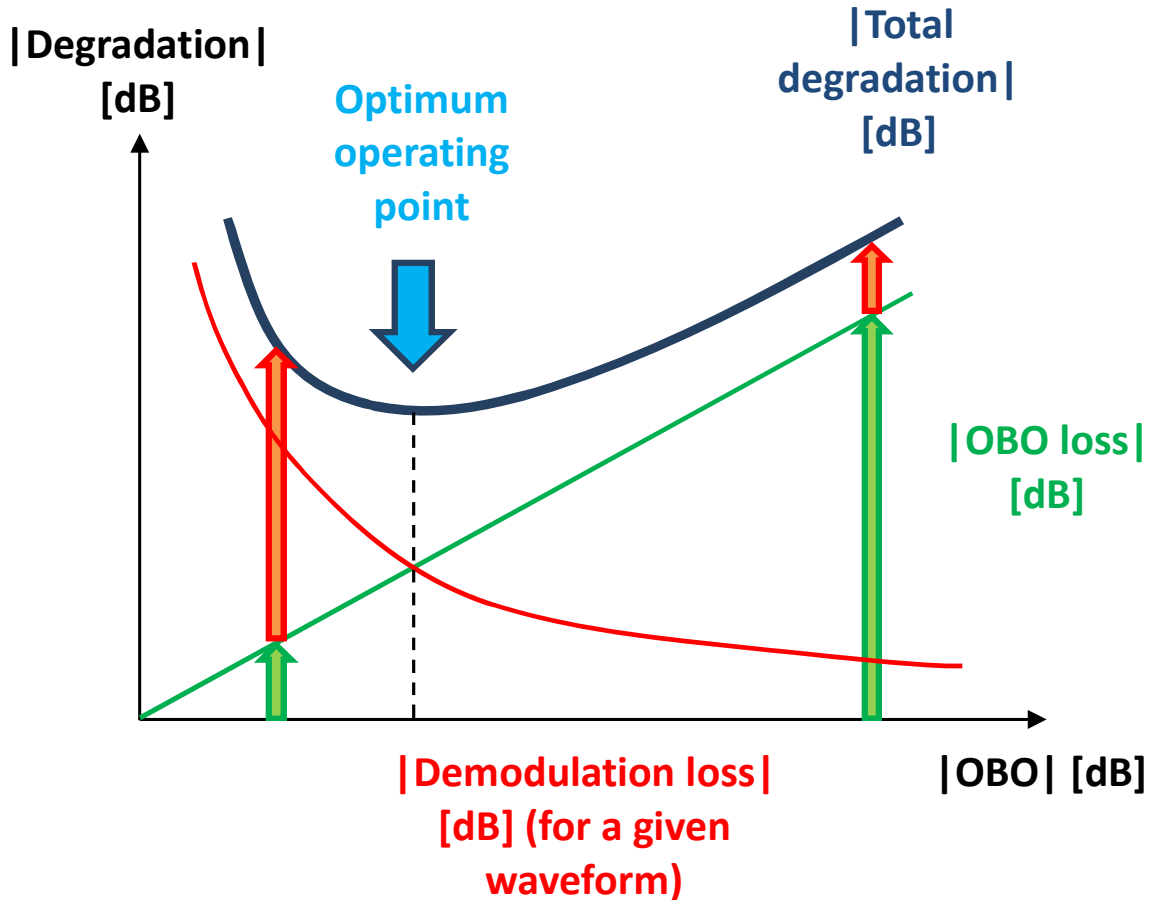

Figure 5-4: Principle of Amplifier Operating Point Optimization

5.3.3 SIMULATION HYPOTHESES

Results are obtained using the simulation tool presented in reference [8], in which the receiver shown in figure 3-3 is used. This tool includes the receiver shown in figure 3-3. Short FECFRAME is used to limit the simulation time. Pilot symbols are inserted. The roll-off is chosen equal to 0.2.

A typical European 26 GHz non-linearized Travelling Wave Tube Amplifier (TWTA) (used in reference [15] and with characteristics roughly similar to the ones in figure H.12 of reference [2]) is assumed. It is fully characterized by Continuous Wave (CW) AM/AM and AM/PM responses shown in figure 5-5. No digital predistortion of the amplifier non-linearity is considered here. Other channel impairments are not considered for the sake of interpretability of results.

Usually, the relationship between Input Back-Off (IBO) and OBO depends on the waveform. It is, for instance, different for CW and modulated signals. It also depends on the roll-off and the constellation of a modulated signal.

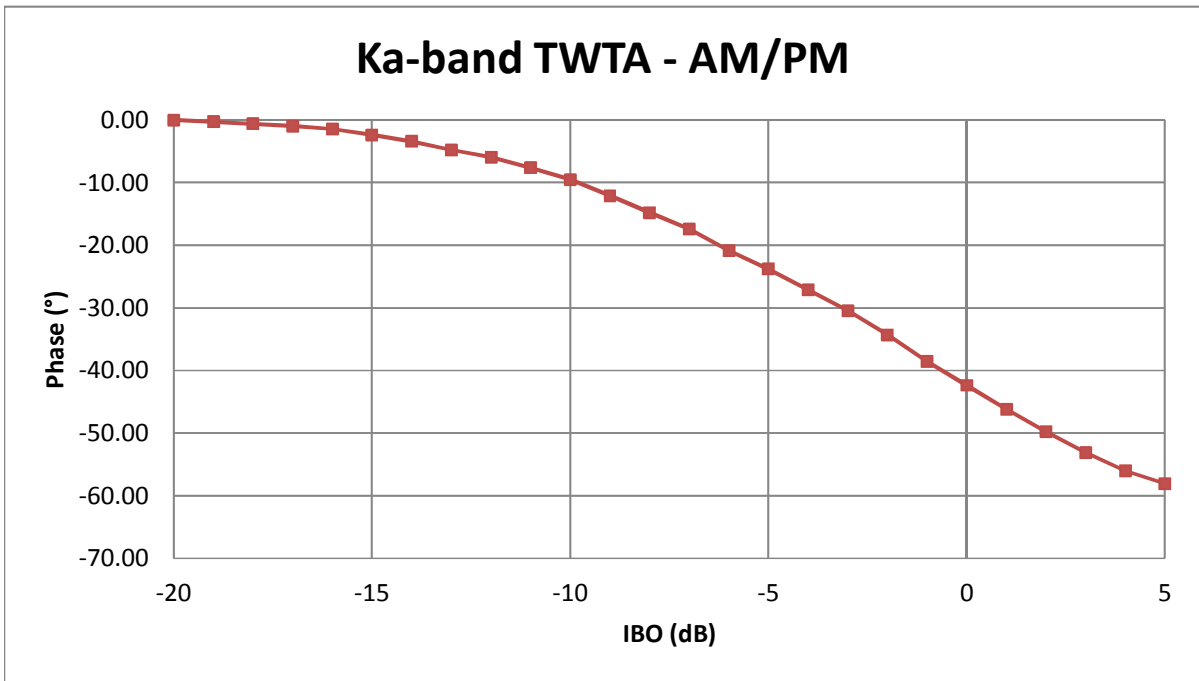
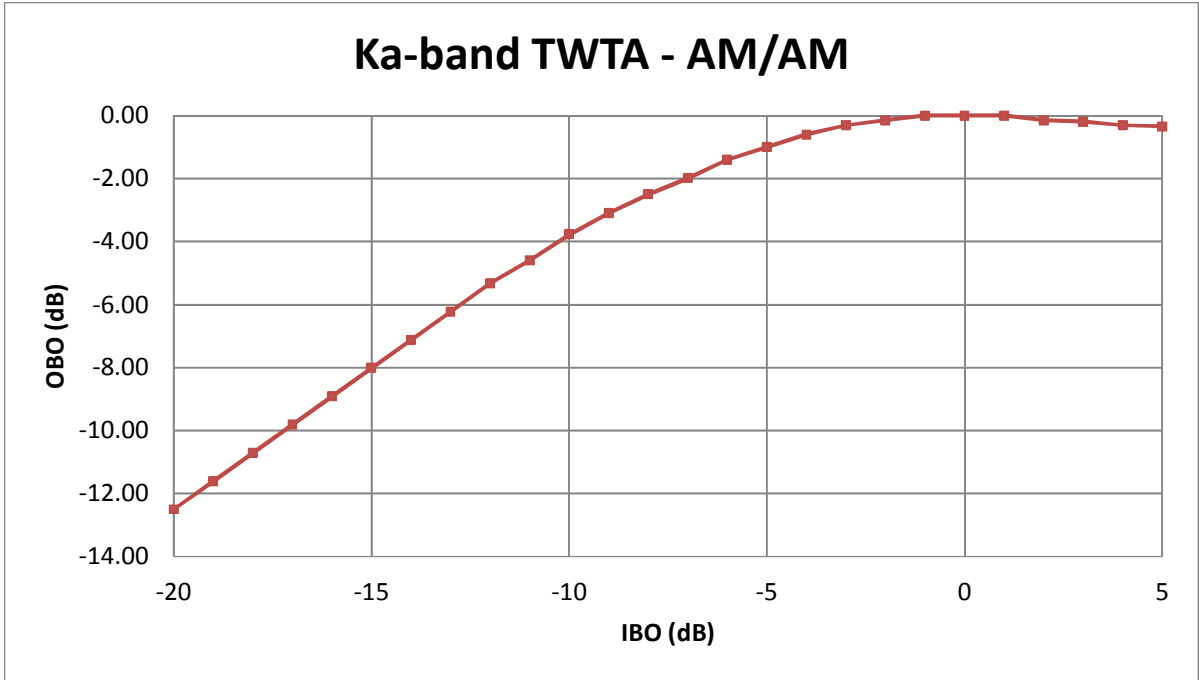

Figure 5-5: 26 GHz Power Amplifier AM/AM and AM/PM Responses

5.3.4 OPTIMUM OPERATING POINT OPTIMIZATION FOR 16APSK 8/9

The optimization for 16APSK 8/9 is shown in figure 5-6.

The optimal operating point is an |IBO| of 5.5 dB corresponding to an |OBO| of 1.75 dB.

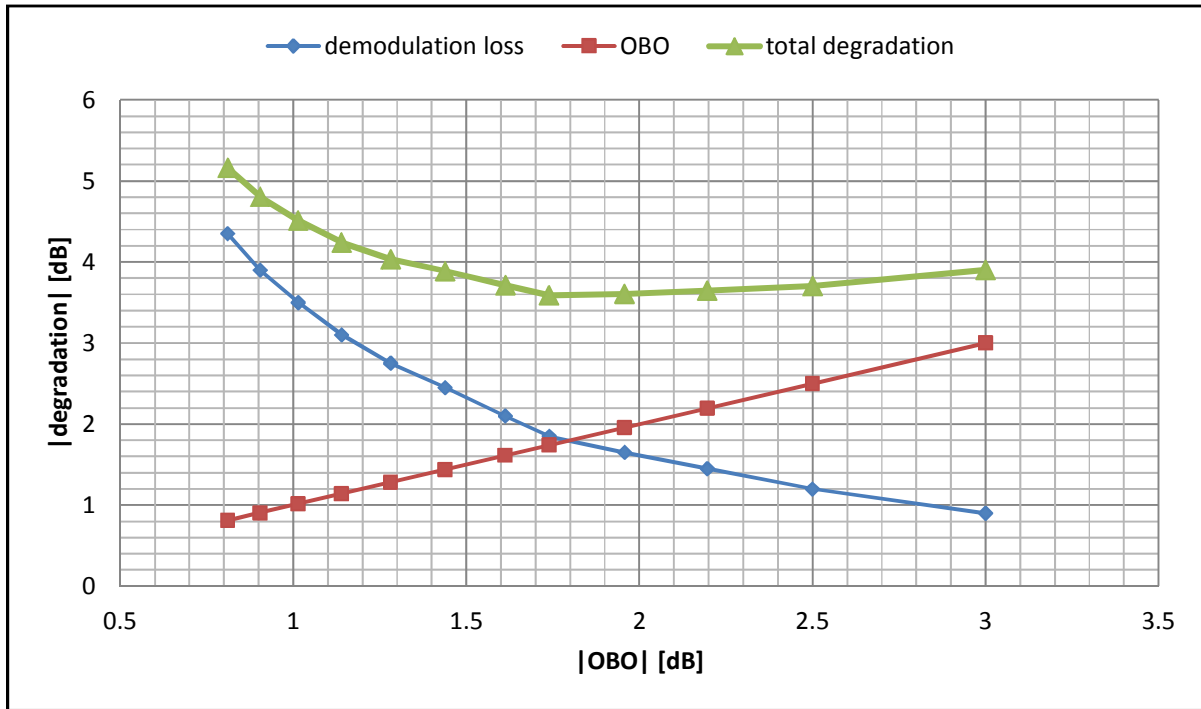

Figure 5-6: Amplifier Operating Point Optimization for 16APSK 8/9

5.3.5 RESULTS WITH CONSTANT IBO

If a MODCOD change is required, the most straightforward way, though not optimum, may be in some cases to operate at the same IBO operating point over a mission range of MODCODs.

Results for different MODCODs from QPSK 1/3 to 16APSK 8/9 with the previous IBO are thus presented in figure 5-7.

For a given constellation, the demodulation loss decreases with the coding rate, thanks to the decrease of the required E_s/N_0 over AWGN channel.

However, if high coding rate 8PSK and low coding rate 16APSK have similar required E_s/N_0 over AWGN channel, 16APSK shows a more important demodulation loss with non-linearity, because of its higher Peak-to-Average Power Ratio (PAPR).

CCSDS PROTOCOLS OVER DVB-S2—SUMMARY OF DEFINITION,
IMPLEMENTATION, AND PERFORMANCE

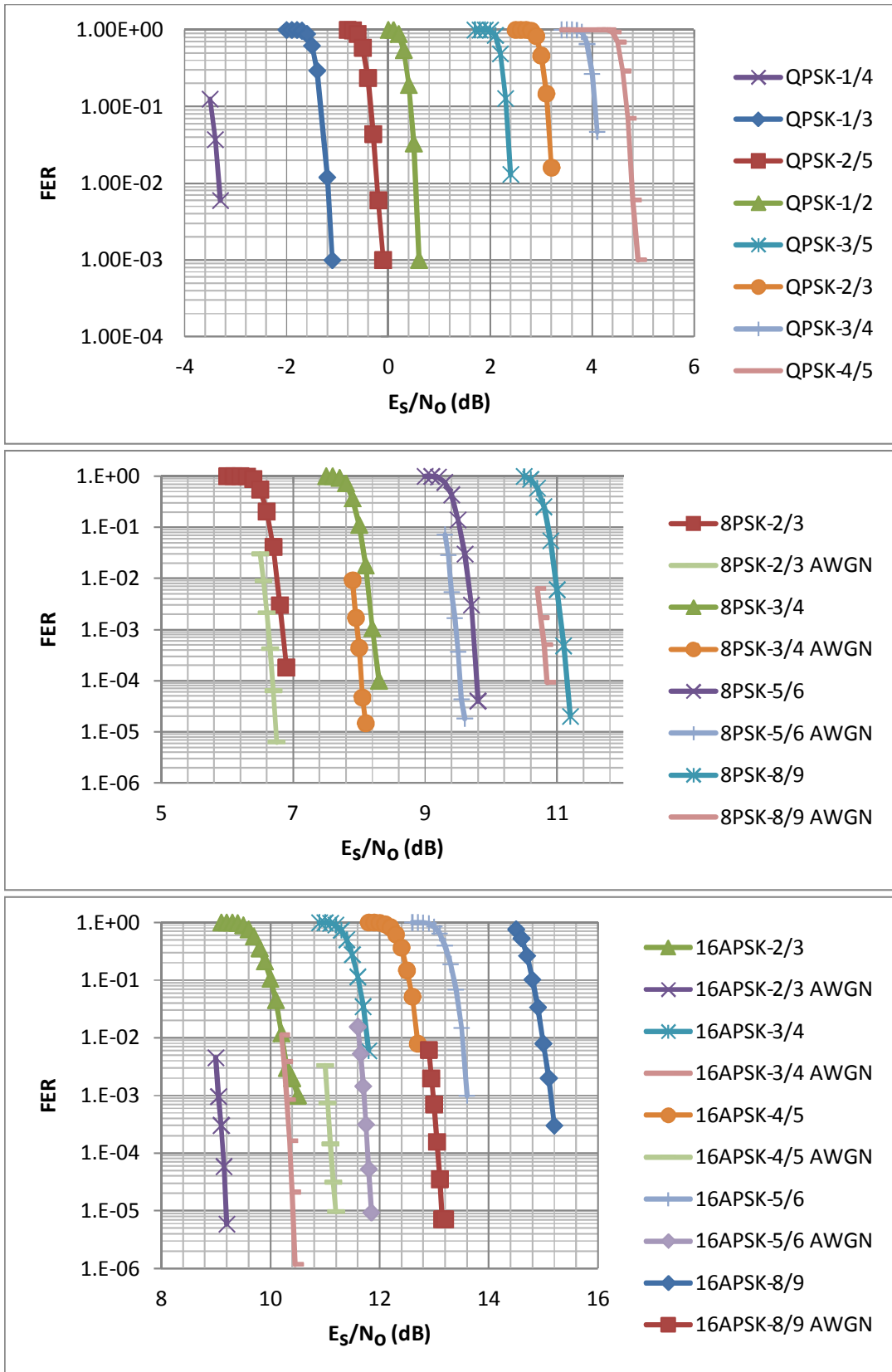

Figure 5-7: Performance with Constant $|IBO|= 5.5$ dB

Because of the even higher PAPR of 32APSK, it does not appear possible to reach the target FER with the considered IBO. For that reason, it is necessary to consider a specific IBO optimization for the case of MODCODs with 32APSK modulation.

The optimization for 32APSK 8/9 is shown in figure 5-8. The optimal operating point is an |IBO| of 11 dB corresponding to an |OBO| of 4.95 dB.

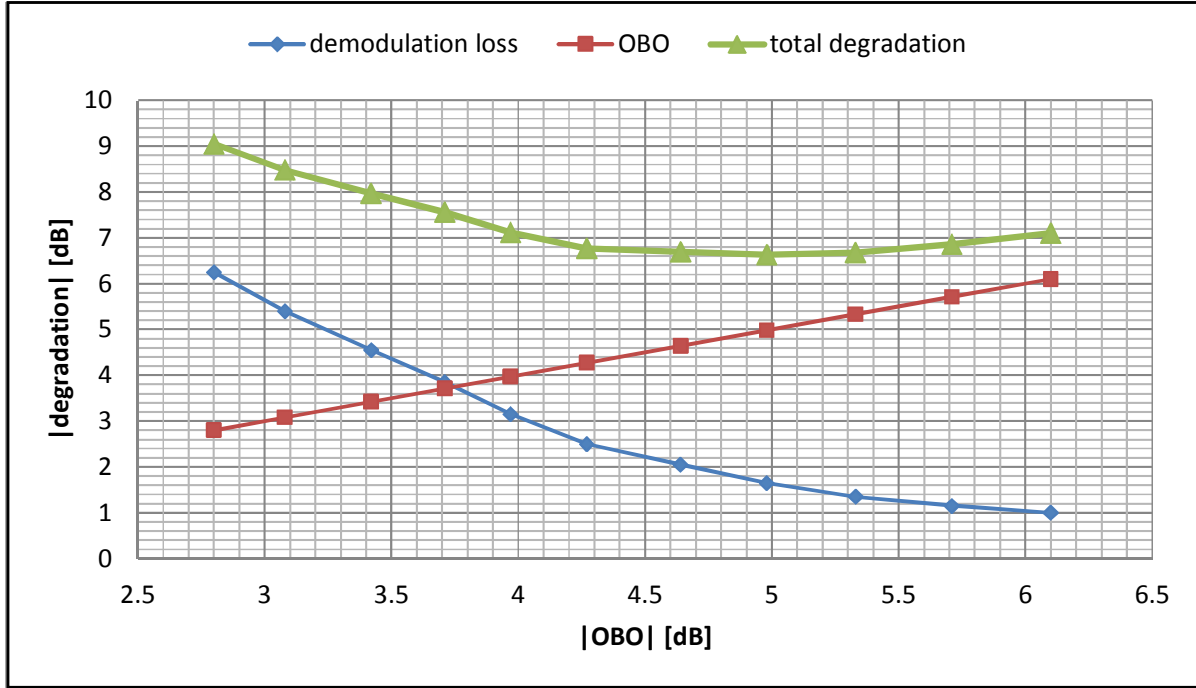

Figure 5-8: Amplifier Operating Point Optimization for 32APSK 8/9

5.3.6 COMMENTS

The basis for optimization of the amplifier operating point was presented, considering DVB-S2 nominal constellations. Another simple way to further increase performance is to use static digital predistortion of the amplifier non-linearity, for 16APSK and 32APSK, at the constellation mapping level in the transmitter. Such a predistortion is working at the symbol rate, and thus its digital complexity is very limited. For a given MODCOD using 16APSK or 32APSK, a joint optimization of the predistorted constellation and of the operating point is then possible. Such an optimization is proposed in 5.4.

When considering a VCM or even ACM transmission, a simple solution consists in optimizing the amplifier operating point for a median MODCOD, and then in keeping a constant IBO for the different MODCODs.

When considering a VCM or even ACM transmission, a full performance solution requires a dynamic adaptation of the amplifier operating point depending on the MODCOD. (The implementation of such a solution is beyond the scope of this document.)

5.4 EXAMPLE OF PERFORMANCE WITH STATIC PREDISTORTION OF POWER AMPLIFIER NON-LINEARITY

5.4.1 INTRODUCTION

The objective of this subsection is:

- to present some additional material about Power Amplifier (PA) operating point optimization when using DVB-S2 High Order Modulations (HOMs), in particular through EVM (reference [11]) measurements;
- to evaluate the possible improvement when using a very simple symbol Constellation Predistortion (CP) of the PA non-linearity;
- to evaluate possible constraints on the amplifier operating point related to the PSD at the PA output.

5.4.2 METHODOLOGY

The model used is the classical model of non-linearity without memory (already used in 5.3): the PA is fully characterized by its AM/AM and AM/PM responses. A typical European non-linearized X-band TWTA used for the HDRT of CNES Pleiades satellites is considered, with characteristics shown in figure 5-9.

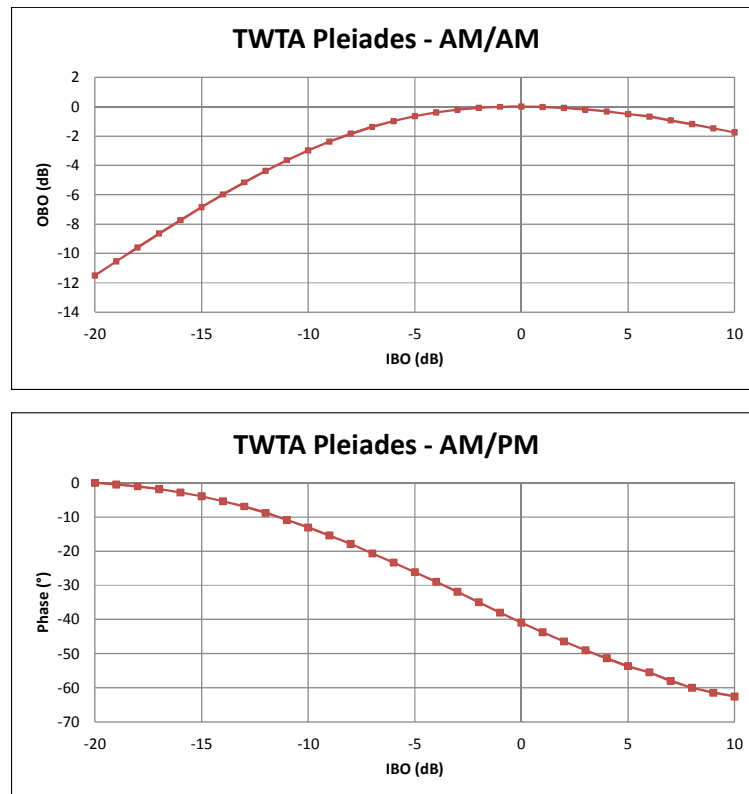

Figure 5-9: AM/AM and AM/PM Responses of the 8 GHz TWTA

In the software simulator used, the receiver synchronization is assumed ideal: simple static amplitude and phase-shift compensations are applied to the received signal to be able to measure the EVM.

In the same way than in 5.3, the value to be minimized (by modifying the PA operating point or the CP) is the Total Degradation (TD), equal to the sum in dB of the OBO and the Demodulation Loss (DL) implied by the non-linearity:

$$TD(\text{dB}) = \text{OBO}(\text{dB}) + \text{DL}(\text{dB})$$

The DL is obtained by the following formula, with natural values:

$$DL = \frac{\frac{C}{N} \text{ required at demodulation with PA non linearity}}{\frac{C}{N} \text{ required at demodulation without PA non linearity}}$$

C is the carrier power and N is the additive noise power measured in the equivalent noise bandwidth (equal to the symbol rate).

It is assumed that the constellation distortion induced by the PA non-linearity has the same behavior as AWGN and acts as interference on the link. The C/I induced by the PA non-linearity is then linked to the measured EVM (without AWGN) by the following formula (see references [11] and [26]), in dB:

$$C / I(\text{dB}) = -20 \log_{10}(\text{EVM}(\%))$$

To make the link possible with the target FER, the received C/(N+I) has to be equal to the required E_s/N_o at the receiver input. The result is, with natural values (see, for example, reference [25]):

$$\left(\frac{C}{N+I} \right)^{-1} = \left(\frac{C}{N} \right)^{-1} + \left(\frac{C}{I} \right)^{-1} = \left(\text{required } \frac{E_s}{N_o} \right)^{-1}$$

or

$$\frac{C}{N} = \left(\left(\text{required } \frac{E_s}{N_o} \right)^{-1} - \left(\frac{C}{I} \right)^{-1} \right)^{-1}$$

Finally, that results in natural values

$$DL = \frac{\left(\left(\text{required} \frac{E_s}{N_o} \right)^{-1} - \left(\frac{C}{I} \right)^{-1} \right)^{-1}}{\text{required} \frac{E_s}{N_o}}$$

or in dB

$$DL(\text{dB}) = 10 \log_{10} \left(1 - 10^{\left(\text{required} \frac{E_s}{N_o}(\text{dB}) - \frac{C}{I}(\text{dB}) \right) / 10} \right)$$

For the exercise a perfect receiver is considered, using the theoretical E_s/N_o values taken from the DVB-S2 (see table 13 in reference [2]). This approximation appears close to reality for modern receivers (see 5.5), at least up to 16APSK.

It is worth noting that throughout this subsection, TD, OBO, and DL are expressed with negative values. It is also interesting that the optimization process considered in this subsection is fully similar to the one considered in 5.3, the only difference being the computation of the DL using EVM measurements in this subsection (of interest to reduce simulation time with respect to 5.3).

5.4.3 QPSK AND 8PSK

The optimization can only be performed on the amplifier operating point (CP is not applicable for constant envelop constellations).

The PAPR is the same for QPSK and 8PSK, because of the constant envelope constellation. However, the PAPR increases when the roll-off alpha value decreases. The demodulation loss induced by the PA (in absolute value) varies in the same direction of the PAPR.

The operating point optimization leads to a higher TD (in absolute value) for 8PSK than for QPSK, because theoretical required E_s/N_o is lower for QPSK than for 8PSK.

It can be noted that for both QPSK and 8PSK, whatever the roll-off is, the best operating point is found very close to the saturation. Figure 5-10 shows the TD for different OBO and for the three highest coding rates (5/6, 8/9 and 9/10) for 8PSK. The blue lines (marker +) are for $\alpha = 0.2$, whereas the green lines (marker o) are for $\alpha = 0.35$.

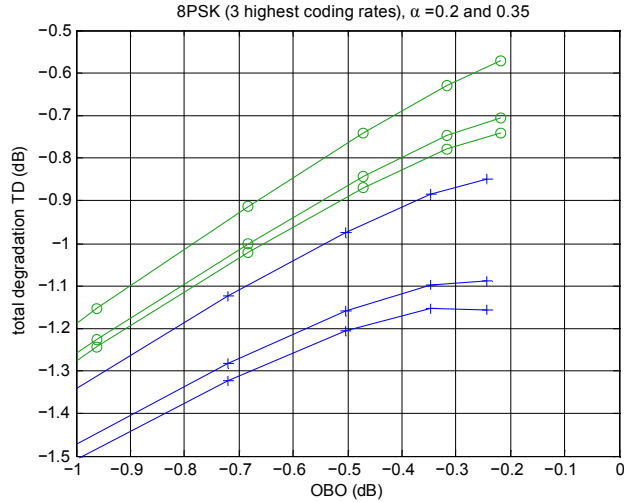

Figure 5-10: TD for 8PSK

5.4.4 16APSK

The optimization is performed on:

- the PA operating point;
- the increase of the radius ratio with respect to the nominal constellation ($\Gamma = \gamma_{CP} / \gamma_{nominal}$);
- the phase shift of the second ring with respect to the nominal constellation ($\Delta\phi$).

The optimization is performed by the brute force approach. For each IBO, an optimal couple ($\Gamma, \Delta\phi$) is found by testing possible values of Γ and $\Delta\phi$. Figure 5-11 shows the TD (in dB) as a function of Γ and $\Delta\phi$, for the case of 16APSK 9/10 and with an IBO equal to -3 dB. The optimal couple ($\Gamma, \Delta\phi$) is about (1.5, 20 degrees) and leads to a TD equal to -2.8 dB.

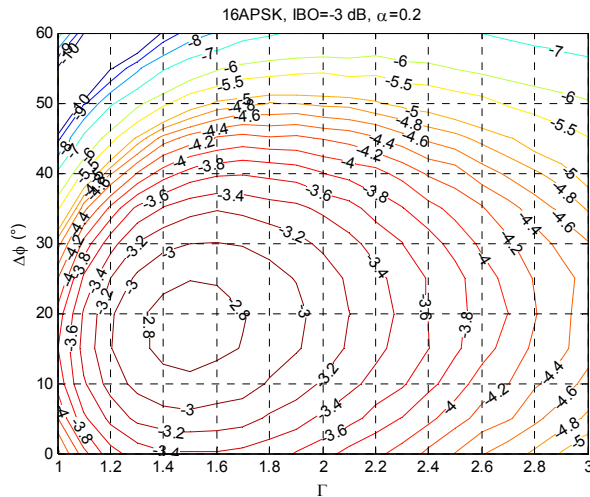

Figure 5-11: TD as a Function of Γ and $\Delta\phi$ for a Fixed IBO

It should be noted that the OBO slightly depends on the waveform and consequently depends on the CP.

Figure 5-12 shows the lowest |TD| for different OBO, and for the six MODCODs with 16APSK modulation of the DVB-S2 standard. The blue lines (marker +) are with CP, whereas the green lines (marker o) are without CP (i.e., with nominal DVB-S2 constellations).

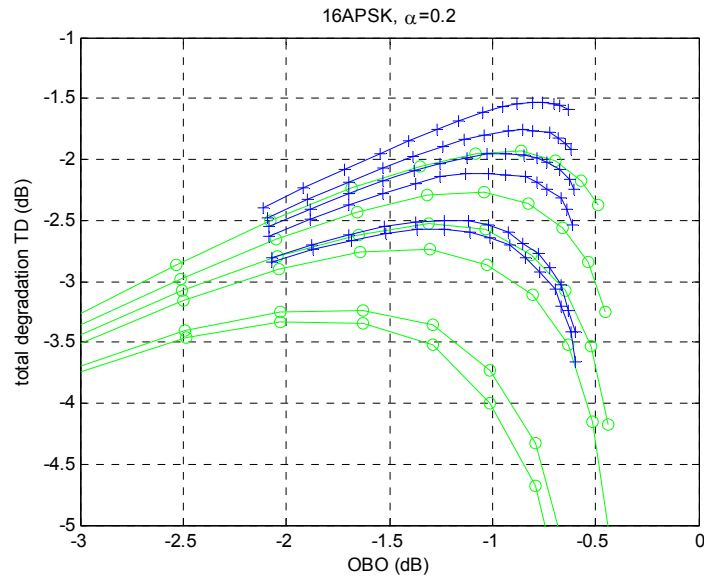

Figure 5-12: Optimal TD for 16APSK

Tables 5-1 and 5-2 summarize the optimal operating point for roll-off $\alpha = 0.2$ and $\alpha = 0.35$. The gain in using CP is found limited: 0.4 to 0.76 dB with $\alpha = 0.2$, 0.55 dB to 1.1 dB with $\alpha = 0.35$. Logically, this gain is slightly higher for the highest roll-off value (the PAPR increase induced by the pulse shaping filter is not mitigable by the CP).

Table 5-1: Optimal Operating Points, 16APSK, Roll-Off $\alpha = 0.2$

MODCOD	With CP							Without CP					(TD with CP) - (TD without CP) (dB)
	IBO (dB)	OBO (dB)	C/I (dB)	TD (dB)	DL (dB)	Γ	$\Delta\phi$ (°)	IBO (dB)	OBO (dB)	C/I (dB)	TD (dB)	DL (dB)	
16APSK 2/3	-1.5	-0.76	16.9	-1.53	-0.77	1.65	17.5	-3	-0.86	15.6	-1.93	-1.07	0.40
16APSK 3/4	-2.5	-0.85	17.5	-1.76	-0.91	1.5	17.5	-4	-1.04	16.3	-2.27	-1.23	0.51
16APSK 4/5	-3	-0.93	17.8	-1.95	-1.02	1.5	20	-5	-1.31	17.15	-2.53	-1.22	0.58
16APSK 5/6	-3.5	-1.05	18.1	-2.11	-1.06	1.45	17.5	-5	-1.3	17.1	-2.74	-1.44	0.63
16APSK 8/9	-4	-1.12	18.5	-2.5	-1.38	1.4	17.5	-6	-1.63	18	-3.24	-1.61	0.74
16APSK 9/10	-5	-1.36	19.3	-2.57	-1.21	1.3	15	-7	-2.03	19	-3.33	-1.3	0.76

Table 5-2: Optimal Operating Points, 16APSK, Roll-Off $\alpha = 0.35$

MODCOD	With CP							Without CP					(TD with CP) - (TD without CP) (dB)
	IBO (dB)	OBO (dB)	C/I (dB)	TD (dB)	DL (dB)	Γ	$\Delta\phi$ (°)	IBO (dB)	OBO (dB)	C/I (dB)	TD (dB)	DL (dB)	
16APSK 2/3	-0.5	-0.71	18.3	-1.25	-0.54	1.85	22.5	-3	-0.86	16.1	-1.8	-0.94	0.55
16APSK 3/4	-1.5	-0.77	18.9	-1.4	-0.63	1.75	22.5	-4	-1.04	16.8	-2.1	-1.06	0.70
16APSK 4/5	-2	-0.82	19.2	-1.53	-0.71	1.7	22.5	-5	-1.3	17.7	-2.35	-1.05	0.82
16APSK 5/6	-2	-0.81	19.3	-1.63	-0.82	1.7	22.5	-5	-1.29	17.7	-2.53	-1.24	0.90
16APSK 8/9	-3	-0.95	19.9	-1.9	-0.95	1.6	20	-6	-1.62	18.6	-2.97	-1.35	1.07
16APSK 9/10	-3.5	-1.04	20.3	-1.97	-0.93	1.55	20	-6	-1.61	18.6	-3.05	-1.44	1.08

5.4.5 32APSK

The optimization is performed on:

- the PA operating point;
- the increase of the second radius ratio with respect to the nominal constellation ($\Gamma_2 = \gamma_{2,CP} / \gamma_{2,nominal}$);
- the phase shift of the third ring with respect to the nominal constellation ($\Delta\phi_2$).

Thus the optimization proposed here is suboptimal, because the optimization could also be performed on $\Gamma_1 = \gamma_{1,CP} / \gamma_{1,nominal}$ and $\Delta\phi_1$. However, the third ring of 32APSK is the most subject to PA compression, and thus the improvement of a more sophisticated approach can be presumed limited. Some results are shown in figure 5-13.

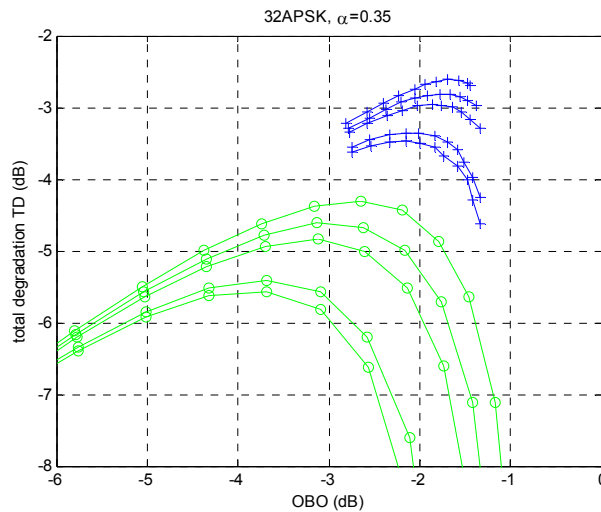

Figure 5-13: Optimal TD for 32APSK

CCSDS PROTOCOLS OVER DVB-S2—SUMMARY OF DEFINITION,
IMPLEMENTATION, AND PERFORMANCE

Tables 5-3 and 5-4 summarize the optimal operating point for roll-off $\alpha = 0.2$ and $\alpha = 0.35$. The gain in using CP is found between 1.25 and 1.46 dB with $\alpha = 0.2$, and between 1.69 and 2.11 dB with $\alpha = 0.35$. In the same way as for 16APSK, this gain is slightly higher for the highest roll-off value.

Table 5-3: Optimal Operating Points, 32APSK, Roll-Off $\alpha = 0.2$

MODCOD	With CP							Without CP					(TD with CP) - (TD without CP) (dB)
	IBO (dB)	OBO (dB)	C/I (dB)	TD (dB)	DL (dB)	Γ	$\Delta\phi$ (°)	IBO (dB)	OBO (dB)	C/I (dB)	TD (dB)	DL (dB)	
32APSK 3/4	-5.5	-1.85	18.7	-3.11	-1.26	1.35	15	-8	-2.65	17.6	-4.36	-1.71	1.25
32APSK 4/5	-6	-2	19.2	-3.39	-1.39	1.35	12.5	-9	-3.14	18.8	-4.72	-1.58	1.33
32APSK 5/6	-6.5	-2.14	19.7	-3.6	-1.46	1.3	12.5	-9	-3.13	18.9	-4.98	-1.85	1.38
32APSK 8/9	-8	-2.71	21.2	-4.13	-1.42	1.2	10	-10	-3.69	20.2	-5.56	-1.87	1.43
32APSK 9/10	-8	-2.71	21.2	-4.3	-1.59	1.2	10	-10	-3.69	20.2	-5.76	-2.07	1.46

Table 5-4: Optimal Operating Points, 32APSK, Roll-Off $\alpha = 0.35$

MODCOD	With CP							Without CP					(TD with CP) - (TD without CP) (dB)
	IBO (dB)	OBO (dB)	C/I (dB)	TD (dB)	DL (dB)	Γ	$\Delta\phi$ (°)	IBO (dB)	OBO (dB)	C/I (dB)	TD (dB)	DL (dB)	
32APSK 3/4	-4.5	-1.7	19.9	-2.61	-0.91	1.55	17.5	-8	-2.65	17.7	-4.3	-1.65	1.69
32APSK 4/5	-5	-1.78	20.4	-2.81	-1.03	1.5	17.5	-9	-3.14	19	-4.61	-1.47	1.80
32APSK 5/6	-5.5	-1.86	20.8	-2.96	-1.1	1.4	15	-9	-3.12	19.1	-4.84	-1.72	1.88
32APSK 8/9	-6.5	-2.15	21.8	-3.36	-1.21	1.35	12.5	-10	-3.68	20.5	-5.41	-1.73	2.05
32APSK 9/10	-6.5	-2.15	21.9	-3.47	-1.32	1.35	15	-10	-3.68	20.6	-5.58	-1.9	2.11

5.4.6 PSD AND ACPR

The PSD presented here is **PSD at the PA output, whereas SFCG mask is applicable at the satellite output** (in particular possibly after a highly selective RF output filter). PSD is here normalized at the carrier center. SFCG PSD mask is computed depending on the constellation as in SFCG recommendation 21-2R3 in reference [12].

The spectra are identical for QPSK and 8PSK. Moreover, the spectrum is not significantly dependent on the constellation (possibly with TD) for the different MODCODs with 16APSK modulation or for the different MODCODs with 32APSK modulation. Consequently, results are only presented for 8PSK, 16APSK 5/6, and 32APSK 5/6 in figure 5-15. It appears quite achievable to respect the SFCG mask with the considered PA.

Adjacent Channel Power Ratio (ACPR) refers here to the ratio in natural value between the PSD at the carrier center and the maximum PSD above a given frequency offset from the carrier center, as shown in figure 5-14. **This ACPR is computed at the PA output (and not at the satellite output)**. A possible use of the ACPR results shown in figure 5-16, for a user knowing some mission requirements (carrier frequency, symbol rate noted R_s in figure 5-16, Equivalent Isotropic Radiated Power [EIRP], altitude), is to deduce the specification of an RF output filter to avoid coordination with the Deep Space Network (DSN).

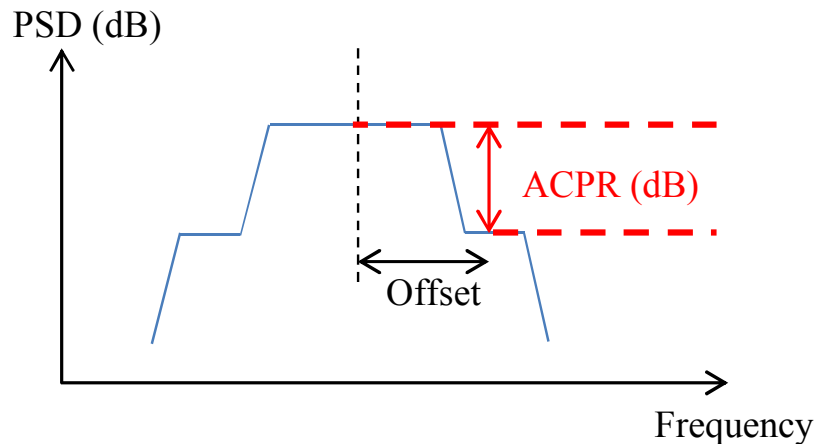

Figure 5-14: Illustration of ACPR Measurement

CCSDS PROTOCOLS OVER DVB-S2—SUMMARY OF DEFINITION,
IMPLEMENTATION, AND PERFORMANCE

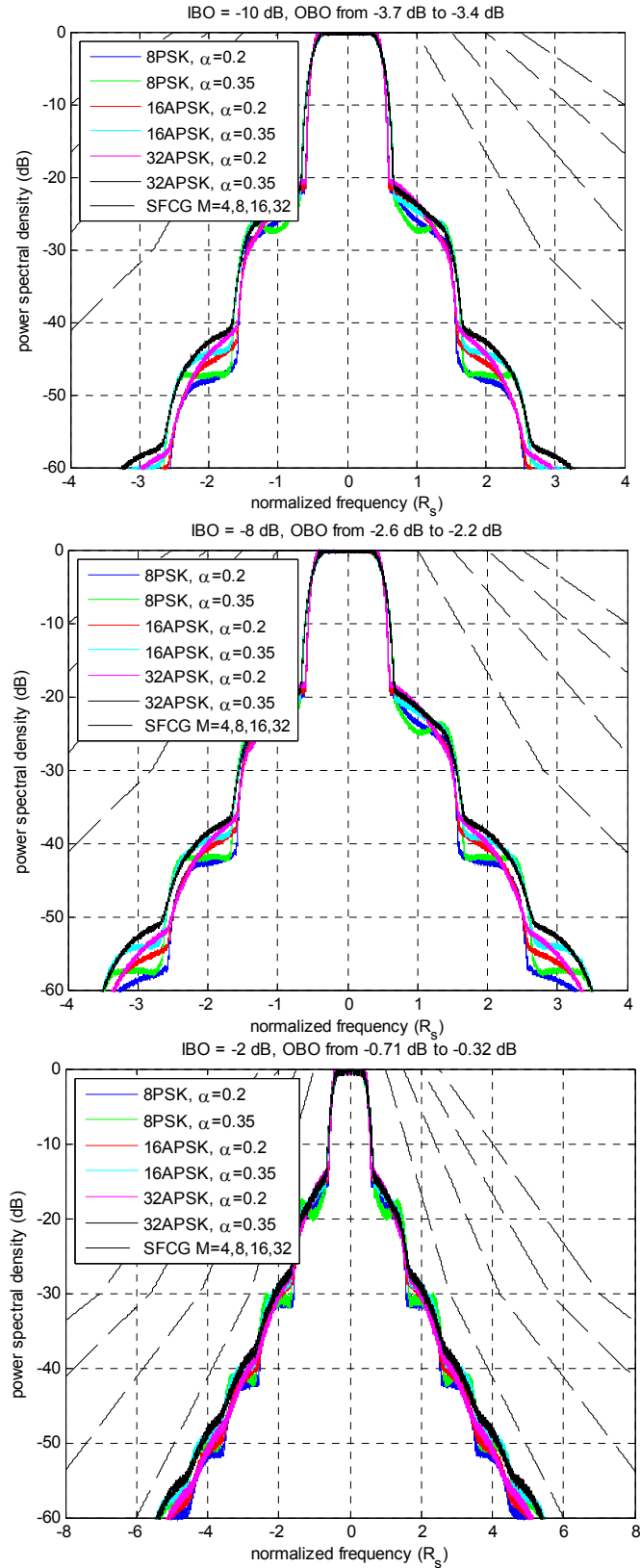

Figure 5-15: PSD at the PA Output for Various IBO

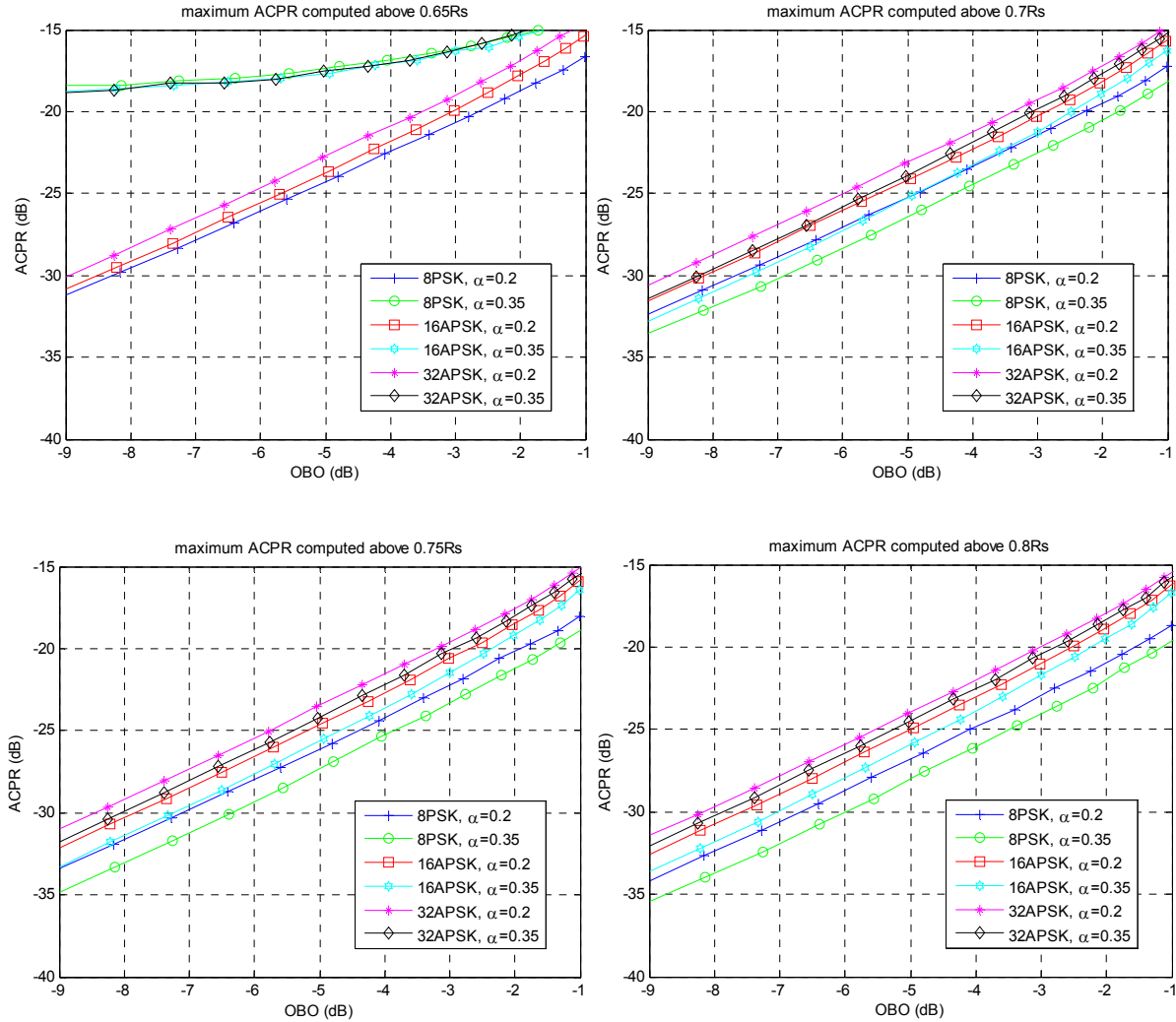

Figure 5-16: ACPR at the PA Output

5.5 EXAMPLE OF DEMODULATION LOSS MEASURED ON AN HDRT RECEIVER

This subsection provides an example of demodulation loss for a modern apparatus including an HDRT receiver and a test transmitter. No channel impairment except AWGN is considered for the measurement. The roll-off value 0.35, normal FECFRAME is used, and pilot symbols are inserted.

The results are shown in table 5-5.

It is worth noting that:

- these results were obtained without dynamic equalization (hence slightly better results seem achievable);

CCSDS PROTOCOLS OVER DVB-S2—SUMMARY OF DEFINITION,
IMPLEMENTATION, AND PERFORMANCE

- the demodulation loss includes degradation from the test transmitter and from the receiver.

For the lowest coding rates of a given modulation, the demodulation loss is higher than for other coding rates because of the higher noise level in the carrier tracking loop.

For the highest coding rates of a given modulation, the demodulation loss can be slightly higher than for the medium coding rates because of the predominance of the intersymbol interference (because of the imperfect frequency flat channel with wideband carriers) under high E_s/N_o conditions.

Table 5-5: Example of Demodulation Loss Measured on a Modern Receiver

	MODCOD	Ideal required E_s/N_o (dB)	Demodulation Loss 100 Mbauds (dB)	Demodulation Loss 300 Mbauds (dB)	Demodulation Loss 500 Mbauds (dB)	Demodulation Loss 600 Mbauds (dB)
QPSK	1	-2.35	1.6	1.3	1.3	1.2
	2	-1.24	1.5	1.4	1.1	1.4
	3	-0.3	1.5	1.1	1.0	1.1
	4	1	1.1	0.7	0.7	0.9
	5	2.23	0.9	0.7	0.7	0.8
	6	3.1	0.7	0.5	0.5	0.6
	7	4.03	0.7	0.5	0.5	0.7
	8	4.68	0.6	0.4	0.5	0.6
	9	5.18	0.6	0.4	0.5	0.6
	10	6.2	0.6	0.4	0.6	0.6
	11	6.42	0.7	0.4	0.6	0.6
8PSK	12	5.5	1.5	1.3	1.2	1.5
	13	6.62	1.2	1.0	1.0	1.1
	14	7.91	1.1	0.9	0.9	1.0
	15	9.35	0.9	1.0	0.8	1.0
	16	10.69	0.7	0.6	0.7	0.8
	17	10.98	0.7	0.5	0.7	0.8
16APSK	18	8.97	1.0	0.9	1.0	0.9
	19	10.21	0.9	0.8	1.0	0.9
	20	11.03	0.9	0.7	0.9	0.9
	21	11.61	0.7	0.6	0.9	0.8
	22	12.89	0.7	0.6	0.8	0.8
	23	13.13	0.7	0.7	0.9	0.9
32APSK	24	12.73	1.2	1.2	1.7	1.5
	25	13.64	1.2	1.3	1.6	1.5
	26	14.28	1.1	1.1	1.5	1.4
	27	15.69	1.1	1.3	1.6	1.5
	28	16.05	0.9	1.4	1.7	1.6

ANNEX A

ACRONYMS AND TERMS

16APSK	16-ary amplitude and phase shift keying
32APSK	32-ary amplitude and phase shift keying
8PSK	8-ary phase shift keying
ACM	adaptive coding and modulation
ACPR	adjacent channel power ratio
AOS	Advanced Orbiting Systems
ASIC	application specific integrated circuit
ASM	attached synchronization marker
AWGN	additive white gaussian noise
BB	baseband
BBFRAME	baseband frame in the DVB-S2 standard
BBHEADER	header of bbframe in the DVB-S2 standard
BCH	Bose-Chaudhuri-Hocquenghem
BPSK	binary phase shift keying
CADU	channel access data unit
CCM	constant coding and modulation
CCSDS	Consultative Committee for Space Data Systems
CP	constellation predistortion
CRC	cyclic redundancy check
dBK	decibel-kilowatt
dBW	decibel-watt
DFL	data field length in the DVB-S2 standard
DL	demodulation loss
DVB	Digital Video Broadcasting project
DVB-S2	DVB system of second generation for satellite broadcasting
E_b/N_0	bit energy and noise power spectral density ratio
EESS	Earth Exploration Satellites Systems
EIRP	equivalent isotropic radiated power
E_s/N_0	channel symbol energy and noise power spectral density ratio
ETSI	European Telecommunications Standards Institute
FEC	forward error correction
FECFRAME	forward error correction frame in the DVB-S2 standard

CCSDS PROTOCOLS OVER DVB-S2—SUMMARY OF DEFINITION,
IMPLEMENTATION, AND PERFORMANCE

FER	FECFRAME error rate
GS	generic stream
HDRT	high data rate telemetry
IBO	input back-off
ITU	International Telecommunications Union
LDPC	low density parity check
LLR	log-likelihood ratio
LVDS	low voltage differential signaling
MATYPE	mode adaptation type
MODCOD	modulation and coding identifier of the DVB-S2 standard
MPEG	Moving Pictures Experts Group
MSB	most significant bit
NA	not applicable
OBO	output back-off
OID	only idle data in its data field
OSI	Open Systems Interconnection
PA	power amplifier
PFD	power flux density
PSD	power spectral density
PLFRAME	physical layer frame in the DVB-S2 standard
PLHEADER	header of the PLFRAME in the DVB-S2 standard
QPSK	quaternary phase shift keying
RF	radio frequency
SFCG	Space Frequency Coordination Group
SNR	signal power to noise power ratio
SOF	start of frame
SRC	square root raised cosine shaping
SYNC	synchronization byte
TD	total degradation
TM	telemetry
TWTA	travelling wave tube amplifier
VCM	variable coding and modulation
VHDL	VHSIC Hardware Description Language

ANNEX B

EXAMPLE OF SYSTEM PERFORMANCE WHEN USING DVB-S2 VCM AND ACM

Example 1

Hypotheses:

- X-band EESS with VCM
- DVB-S2 with normal FECFRAME, pilots, all MODCODs
- Heliosynchronous satellite at 700 km height
- Earth station in Toulouse (France) with clear sky $G/T = 30.5 \text{ dBK}^{-1}$ at 5-degree elevation
- One HDRT channel at 300 Ms/s
- Pointed antenna
- Average data rate computed on all satellite passes with elevation > 5 degrees
- C/I = overall interference on the link (transmitter own degradation, power amplifier non-linearity, intersymbol interference, potential cross-polarization interference)
- Unavailability for tropospheric propagation equal to 1 percent
- ITU recommendations for tropospheric propagation
- System margin 3 dB

Results:

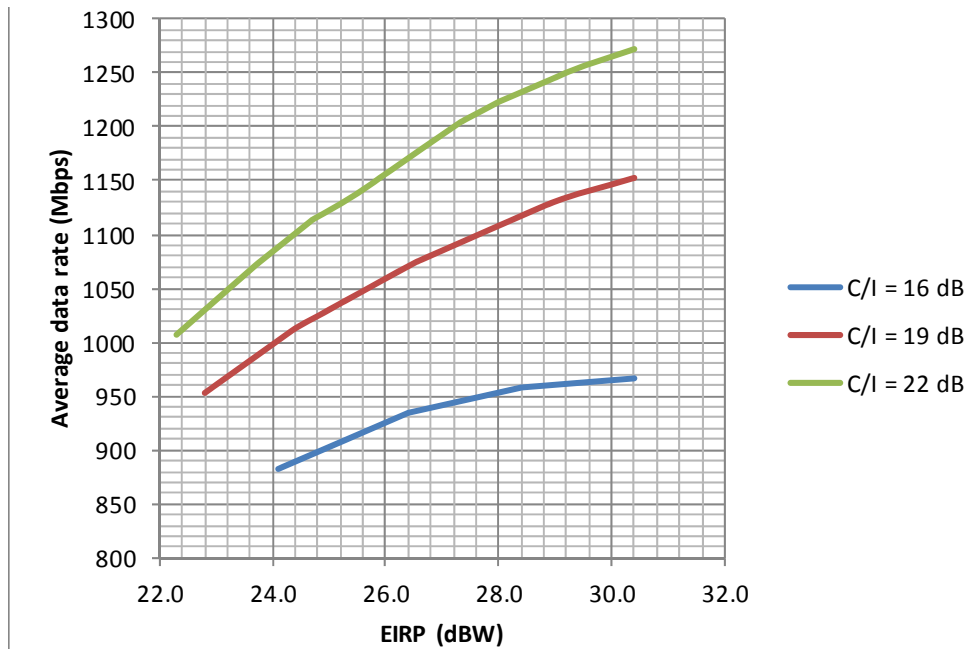

Remark: it appears possible to consider two channels at 300 Ms/s (1 channel per polarization).

Example 2

Hypotheses:

- Ka-band EESS with VCM or ACM
- DVB-S2 with normal FECFRAME, pilots, all MODCODs
- Heliosynchronous satellite at 600 km height
- Earth station in Toulouse (France) or Paris (France) with clear sky $G/T = 36 \text{ dBK}^{-1}$ at 5-degree elevation
- One HDRT channel at 500 Ms/s
- Pointed antenna with EIRP 38.4 dBW
- Average data rate computed on all satellite passes with elevation > 5 degrees
- C/I = overall interference on the link (transmitter own degradation, power amplifier non-linearity, intersymbol interference, potential cross-polarization interference) = 19 dB
- ITU recommendations for tropospheric propagation
- System margin 3 dB

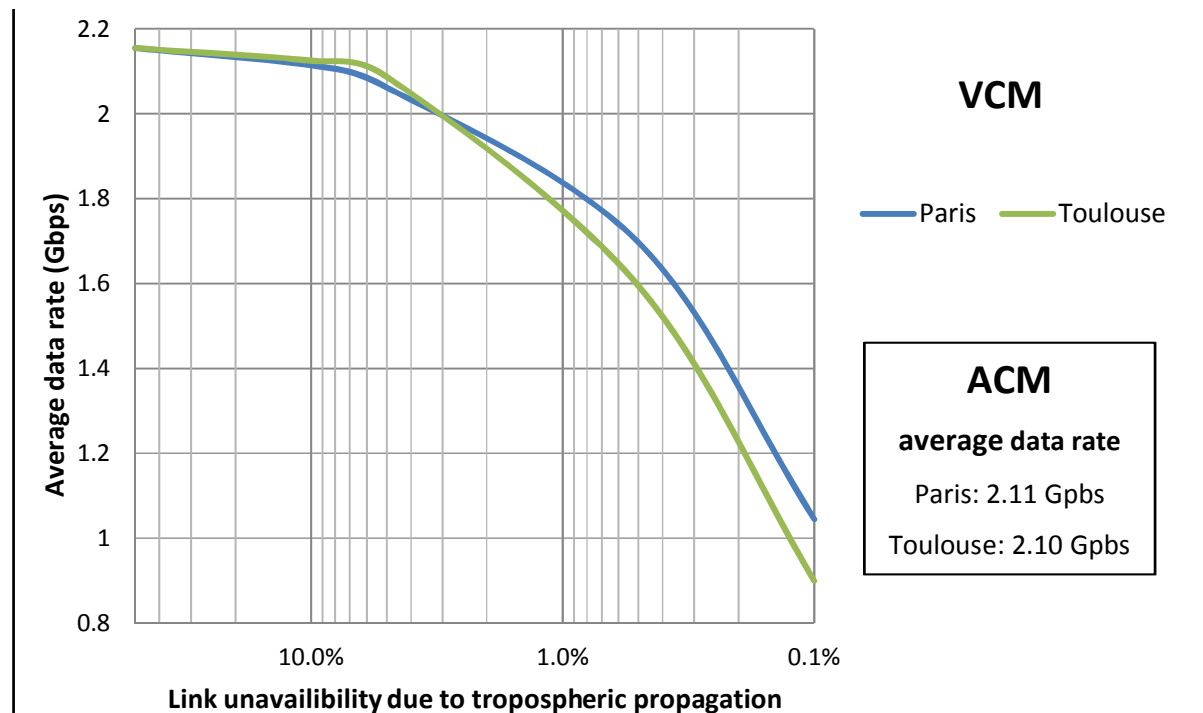

Remark: it appears possible to consider four channels at 500 Ms/s (2 channels per polarization).

ANNEX C

POINTERS TO ETSI DVB-S2 USER GUIDELINES (REFERENCE [3]) SECTIONS OF INTEREST FOR TELEMETRY APPLICATIONS, AND TO OTHER TECHNICAL REPORTS OF INTEREST FOR RECEIVER IMPLEMENTATION

ETSI DVB-S2 User Guidelines (reference [3])

Section 4.3.2.1 (p. 19): single carrier per transponder configuration.

4.3.2.1.1: sensitivity to satellite power amplifier characteristics.

4.3.2.1.2: sensitivity to roll-off.

Annex A (p. 63): Low Density Parity Check Codes.

A.1: Structure of Parity Check Matrices of Standardized LDPC Codes.

A.2: Description of Standardized LDPC Codes.

A.3: Performance Results.

Annex B (p. 69): DVB-S2 Physical Layer Frame and pilot structure.

B.1: Structured PLS code Frame Synchronization.

B.2: Pilot Structure.

Annex C (p. 73): Modem algorithms design and performance over typical satellite channels.

C.1: Modulator with predistortion.

C.2: Clock recovery.

C.3: Physical Layer Frame Synchronization.

C.3.1: An algorithm for Frame Synchronization.

C.3.2: An Alternative Frame Synchronization Algorithm.

C.3.2.1: Acquisition procedure description.

C.3.2.2: Performance Analysis.

C.3.2.3: Acquisition parameters optimization.

C.4: Carrier Frequency Recovery.

C.5: Automatic Gain Control.

C.6: Carrier Phase Recovery.

C.6.1: Pilot-Aided Linear Interpolation.

C.6.2: Fine Phase Recovery for High Order Modulations.

C.7: Performance Results.

Annex E.1 (p. 95): Channel estimator.

Other technical reports

Frame synchronization: reference [22].

SNR estimation: references [16] and [17].

LLR computation: references [19], [20], and [21].

LDPC decoding: references [18], [23], and [24].