

**Research and Development for
Space Data System Standards**

**OPTICAL HIGH DATA
RATE (HDR)
COMMUNICATION—
1064 NM**

EXPERIMENTAL SPECIFICATION

CCSDS 141.11-O-1

ORANGE BOOK
December 2018

**Research and Development for
Space Data System Standards**

**OPTICAL HIGH DATA
RATE (HDR)
COMMUNICATION—
1064 NM**

EXPERIMENTAL SPECIFICATION

CCSDS 141.11-O-1

ORANGE BOOK
December 2018

AUTHORITY

Issue:	Orange Book, Issue 1
Date:	December 2018
Location:	Washington, DC, USA

This document has been approved for publication by the Consultative Committee for Space Data Systems (CCSDS). The procedure for review and authorization of CCSDS documents is detailed in *Organization and Processes for the Consultative Committee for Space Data Systems* (CCSDS A02.1-Y-4).

This document is published and maintained by:

CCSDS Secretariat
National Aeronautics and Space Administration
Washington, DC, USA
E-mail: secretariat@mailman.ccsds.org

FOREWORD

Attention is drawn to the possibility that some of the elements of this document may be the subject of patent rights. CCSDS has processes for identifying patent issues and for securing from the patent holder agreement that all licensing policies are reasonable and non-discriminatory. However, CCSDS does not have a patent law staff, and CCSDS shall not be held responsible for identifying any or all such patent rights.

Through the process of normal evolution, it is expected that expansion, deletion, or modification of this document may occur. This Experimental Specification is therefore subject to CCSDS document management and change control procedures, which are defined in *Organization and Processes for the Consultative Committee for Space Data Systems* (CCSDS A02.1-Y-4). Current versions of CCSDS documents are maintained at the CCSDS Web site:

<http://www.ccsds.org/>

Questions relating to the contents or status of this document should be sent to the CCSDS Secretariat at the e-mail address indicated on page i.

At time of publication, the active Member and Observer Agencies of the CCSDS were:

Member Agencies

- Agenzia Spaziale Italiana (ASI)/Italy.
- Canadian Space Agency (CSA)/Canada.
- Centre National d'Etudes Spatiales (CNES)/France.
- China National Space Administration (CNSA)/People's Republic of China.
- Deutsches Zentrum für Luft- und Raumfahrt (DLR)/Germany.
- European Space Agency (ESA)/Europe.
- Federal Space Agency (FSA)/Russian Federation.
- Instituto Nacional de Pesquisas Espaciais (INPE)/Brazil.
- Japan Aerospace Exploration Agency (JAXA)/Japan.
- National Aeronautics and Space Administration (NASA)/USA.
- UK Space Agency/United Kingdom.

Observer Agencies

- Austrian Space Agency (ASA)/Austria.
- Belgian Federal Science Policy Office (BFPO)/Belgium.
- Central Research Institute of Machine Building (TsNIIMash)/Russian Federation.
- China Satellite Launch and Tracking Control General, Beijing Institute of Tracking and Telecommunications Technology (CLTC/BITTT)/China.
- Chinese Academy of Sciences (CAS)/China.
- China Academy of Space Technology (CAST)/China.
- Commonwealth Scientific and Industrial Research Organization (CSIRO)/Australia.
- Danish National Space Center (DNSC)/Denmark.
- Departamento de Ciência e Tecnologia Aeroespacial (DCTA)/Brazil.
- Electronics and Telecommunications Research Institute (ETRI)/Korea.
- European Organization for the Exploitation of Meteorological Satellites (EUMETSAT)/Europe.
- European Telecommunications Satellite Organization (EUTELSAT)/Europe.
- Geo-Informatics and Space Technology Development Agency (GISTDA)/Thailand.
- Hellenic National Space Committee (HNSC)/Greece.
- Hellenic Space Agency (HSA)/Greece.
- Indian Space Research Organization (ISRO)/India.
- Institute of Space Research (IKI)/Russian Federation.
- Korea Aerospace Research Institute (KARI)/Korea.
- Ministry of Communications (MOC)/Israel.
- Mohammed Bin Rashid Space Centre (MBRSC)/United Arab Emirates.
- National Institute of Information and Communications Technology (NICT)/Japan.
- National Oceanic and Atmospheric Administration (NOAA)/USA.
- National Space Agency of the Republic of Kazakhstan (NSARK)/Kazakhstan.
- National Space Organization (NSPO)/Chinese Taipei.
- Naval Center for Space Technology (NCST)/USA.
- Research Institute for Particle & Nuclear Physics (KFKI)/Hungary.
- Scientific and Technological Research Council of Turkey (TUBITAK)/Turkey.
- South African National Space Agency (SANSA)/Republic of South Africa.
- Space and Upper Atmosphere Research Commission (SUPARCO)/Pakistan.
- Swedish Space Corporation (SSC)/Sweden.
- Swiss Space Office (SSO)/Switzerland.
- United States Geological Survey (USGS)/USA.

DOCUMENT CONTROL

Document	Title	Date	Status
CCSDS 141.11-O-1	Optical High Data Rate (HDR) Communication—1064 NM, Experimental Specification, Issue 1	December 2018	Original issue
EC1	Editorial change 1	January 2019	Corrects graphics display problems
EC2	Editorial change 2	September 2019	Corrects equation typography

CONTENTS

<u>Section</u>	<u>Page</u>
1 INTRODUCTION.....	1-1
1.1 PURPOSE AND SCOPE.....	1-1
1.2 DOCUMENT STRUCTURE	1-1
1.3 NOMENCLATURE	1-2
1.4 REFERENCES	1-3
2 OVERVIEW	2-1
2.1 GENERAL.....	2-1
2.2 ARCHITECTURE.....	2-1
2.3 SPATIAL ACQUISITION	2-3
2.4 DATA LINK LAYER	2-8
2.5 ARCHITECTURE OF LIA	2-15
3 PHYSICAL LAYER.....	3-1
3.1 TERMINAL A OPTICAL TRANSMIT SIGNAL CHARACTERISTICS.....	3-1
3.2 TERMINAL B OPTICAL SIGNAL CHARACTERISTICS	3-2
3.3 COMMUNICATIONS SIGNAL.....	3-2
3.4 TERMINAL B OPTICAL COMMUNICATIONS SIGNAL CHARACTERISTICS	3-21
4 CODING AND SYNCHRONIZATION	4-1
4.1 TERMINAL A DATA LINK LAYER CHARACTERISTICS.....	4-1
4.2 TERMINAL B DATA LINK LAYER CHARACTERISTICS.....	4-5
ANNEX A SECURITY, SANA, AND PATENT CONSIDERATIONS (INFORMATIVE)	A-1
ANNEX B PHYSICAL LAYER AND CODING AND SYNCHRONIZATION SUBLAYER IMPLEMENTATION (INFORMATIVE).....	B-1
ANNEX C ABBREVIATIONS AND ACRONYMS (INFORMATIVE).....	C-1

Figure

2-1 Relationship with OSI and CCSDS Layers	2-2
2-2 Modes of Beaconless Acquisition According to a Master-Slave Approach	2-6
2-3 Simplified Flow Chart of the Beaconless Spatial Acquisition Algorithm.....	2-7
2-4 Layer Overview for the Example of EDRS Application	2-8

CONTENTS (continued)

<u>Figure</u>	<u>Page</u>
2-5 Layer Overview for the Example of a Symmetrical OISL between Two GEO Relays	2-10
2-6 Block Diagram with Reference Points and Data Rates for the Example of EDRS Application.....	2-11
2-7 Block Diagram with Reference Points and Data Rates for the Example of EDRS Application with Optimized Throughput (Denoted As 600 Mb/s Mode or Sentinel Mode)	2-12
2-8 Requirements on LIA=LIAU for Flexible Relay Network.....	2-14
2-9 Architecture of LIA	2-15
2-10 Sequence of Operations in LIA for Framing	2-16
2-11 Backpressure Concept for LIA=LIAU to Adapt to Given Data Rates on RF Downlink.....	2-17
3-1 Upper Limit for the Frequency Noise of the Tx Laser	3-4
3-2 Mapping of LPC Encoder Input to 5-by-5 Input Matrix	3-9
3-3 Mapping of 5-by-5 Output Matrix to Encoder Output	3-10
3-4 Calculation of $e(0,0)$ to $e(3,3)$	3-11
3-5 Definition of Subblocks within 5-by-5 Output Matrix	3-13
3-6 System Channel Frame	3-16
3-7 Insertion of Inverted Unique Word, Scrambler Reset and Alignment of 3-Tuples.....	3-17
3-8 Format of Service Channel Frame.....	3-18
3-9 Serial Output Data Frame <i>DatSerOut</i>	3-19
3-10 Spectral Mask of the Modulated Base-Band Tx Signal.....	3-19
3-11 Transmit Eye Pattern	3-20
4-1 Data Rates in Flexible Relay Network	4-1
4-2 LIA Frame Header for the General Case	4-2
4-3 LIA Frame Header for the Specific Case of LIA=DRAU	4-3

Table

3-1 Mux and Align Modes	3-5
3-2 Illustration of the Building Rule for the Parallel PRBS Generator	3-7
3-3 Scrambler Reset Definition.....	3-7
3-4 Disparity Calculation	3-14
3-5 Definition of Subblock Inversion	3-15
3-6 Definition of Unique Word and Reserved Pattern.....	3-16
3-7 Short Scrambler Reset Mode Definition.....	3-16
3-8 Service Channel Bit Encoding.....	3-17
3-9 Definitions for the Transmit Eye Pattern in Figure 3-11	3-20

1 INTRODUCTION

1.1 PURPOSE AND SCOPE

The purpose of this Experimental Specification is to define a recommendation for optical communication, taking as reference the implementation in ESA missions (EDRS series, Sentinel series) and the original DLR development. The key technical features are the use of the 1064 nm wavelength with Binary Phase-Shift Keying (BPSK) modulation. In addition, future evolutions with regard to dual-wavelength (1064 nm and 1550 nm), increased data rates (3.6 Gb/s with Reed-Solomon codes and BPSK and up to 10 Gb/s with QPSK), modulation, and coding schemes will be specified in the context of the ESA ScyLight program, a dedicated new ESA framework on optical communication technology, and in the frame of the ESA GlobeNet project.

The Experimental Specification contains the technical specification for implementing the Physical Layer and the Coding and Synchronization (sub)layer of optical systems supporting the High Data Rate (HDR) scenario.

ESA and DLR consider this Experimental Specification to be a candidate for a future CCSDS Recommended Standard for optical systems interoperable with the European Data Relay System (EDRS), for complementary missions like ESA GlobeNet, or even for other dedicated scenarios.

The described optical communications mechanisms will be useful in particular for LEO-GEO and GEO-GEO Inter-Satellite Link (ISL) operational scenarios. However, they can also be used for space-ground and airborne-space links if additional measures are taken, for example, adaptive optics, interleaving, and erasure coding.

This Experimental Specification provides additional proven options for the implementation of optical communication in cases of HDR transmissions, and it should be adopted by ESA for the above-mentioned missions and beyond.

Furthermore, this Experimental Specification will complement the optical communication Recommended Standards for High Photon Efficiency (HPE) and Low Complexity (LC), without overlapping them, but adding a sound candidate for future standardization.

1.2 DOCUMENT STRUCTURE

This document is structured as follows:

- Section 2 provides a brief description of the application scenarios and an overview of the selected Physical Layer characteristics and modulation, coding, and synchronization schemes.
- Section 3 contains the specification of the Physical Layer characteristics of both the transmit and receive terminal implementations.

- Section 4 contains the specification of the coding and synchronization sublayers of the transmit and receive terminal implementations.
- Annex A discusses security, Space Assigned Numbers Authority (SANA), and patent considerations.
- Annex B identifies existing implementations that demonstrate the technologies expounded in this Experimental Specification.
- Annex C is a glossary of abbreviations used in this document.

1.3 NOMENCLATURE

1.3.1 NORMATIVE TEXT

The following conventions apply for the normative specifications in this Experimental Specification:

- a) the words ‘shall’ and ‘must’ imply a binding and verifiable specification;
- b) the word ‘should’ implies an optional, but desirable, specification;
- c) the word ‘may’ implies an optional specification;
- d) the words ‘is’, ‘are’, and ‘will’ imply statements of fact.

NOTE – These conventions do not imply constraints on diction in text that is clearly informative in nature.

1.3.2 INFORMATIVE TEXT

In the normative sections of this document, informative text is set off from the normative specifications either in notes or under one of the following subsection headings:

- Overview;
- Background;
- Rationale;
- Discussion.

1.4 REFERENCES

The following publications contain provisions which, through reference in this text, constitute provisions of this Experimental Specification. At the time of publication, the editions indicated were valid. All publications are subject to revision, and users of this Experimental Specification are encouraged to investigate the possibility of applying the most recent editions of the documents indicated below. The CCSDS Secretariat maintains a register of currently valid CCSDS publications.

- [1] *Information Technology—Open Systems Interconnection—Basic Reference Model: The Basic Model*. 2nd ed. International Standard, ISO/IEC 7498-1:1994. Geneva: ISO, 1994.
- [2] *TM Synchronization and Channel Coding*. Issue 3. Recommendation for Space Data System Standards (Blue Book), CCSDS 131.0-B-3. Washington, D.C.: CCSDS, September 2017.
- [3] *TM Space Data Link Protocol*. Issue 2. Recommendation for Space Data System Standards (Blue Book), CCSDS 132.0-B-2. Washington, D.C.: CCSDS, September 2015.
- [4] *TC Space Data Link Protocol*. Issue 3. Recommendation for Space Data System Standards (Blue Book), CCSDS 232.0-B-3. Washington, D.C.: CCSDS, September 2015.
- [5] *AOS Space Data Link Protocol*. Issue 3. Recommendation for Space Data System Standards (Blue Book), CCSDS 732.0-B-3. Washington, D.C.: CCSDS, September 2015.

2 OVERVIEW

2.1 GENERAL

ESA and DLR consider this Experimental Specification to be a candidate for a future CCSDS Recommended Standard for optical systems interoperable with the EDRS, complementary missions like ESA GlobeNet, or even for other dedicated scenarios.

The described optical communications mechanisms will be particularly useful for LEO-GEO and GEO-GEO Inter-Satellite Link (ISL) operational scenarios. However, they can also be used for space-ground and airborne-space links if additional measures are taken, for example, adaptive optics, interleaving, and erasure coding.

This Experimental Specification provides additional proven options for the implementation of optical communication in cases of HDR transmissions, which option should be adopted by ESA for the above-mentioned missions and beyond.

Furthermore, this Experimental Specification will complement the optical communication Recommended Standards for High Photon Efficiency (HPE) and Low Complexity (LC), without overlapping them, but adding a sound candidate for future standardization.

2.2 ARCHITECTURE

Figure 2-1 illustrates the relationship of this Recommended Standard to the Open Systems Interconnection reference model (reference [1]). Two sublayers of the Data Link Layer are defined for CCSDS space link protocols. The Data Link Protocol sublayer provides functions for producing Transfer Frames; examples are the TM Space Data Link Protocol (reference [3]), the AOS Space Data Link Protocol (reference [5]), and the TC Space Data Link Protocol (reference [4]).

The Optical Communications Coding and Synchronization protocol specified in this Recommended Standard provides the functions of the synchronization and channel coding sublayer of the Data Link Layer for transferring Transfer Frames over an optical space link.

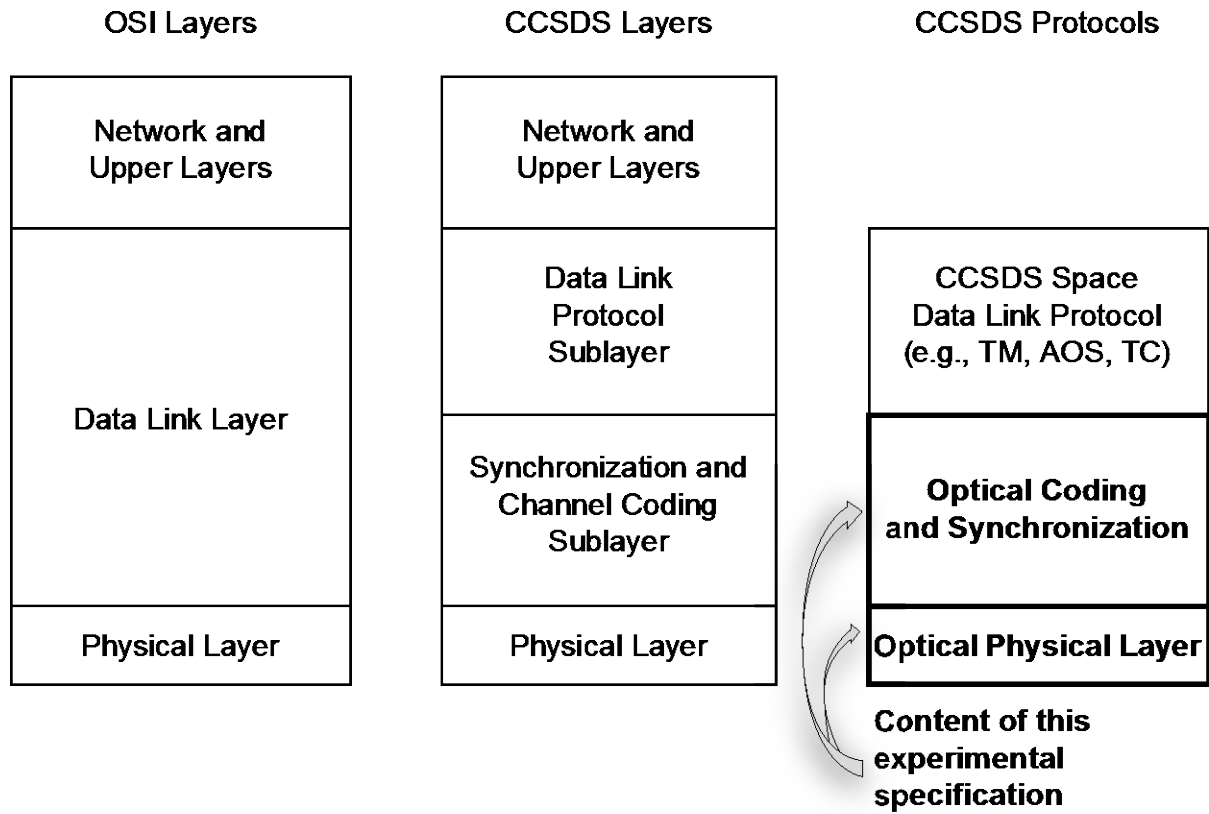

Figure 2-1: Relationship with OSI and CCSDS Layers

2.3 SPATIAL ACQUISITION

2.3.1 BACKGROUND

In order to establish communication between two optical communication terminals, the communication terminals are required to perform a so-called ‘spatial acquisition’ sequence, which ends when spatial tracking is achieved. In coherent optical communication modes, a transition to coherent (frequency) tracking needs to be further executed by locking the transmit laser frequency coherently to the received frequency. In the specific case of homodyne communication modes, the frequency of the local oscillator needs to be adjusted to the signal carrier frequency (frequency acquisition), such that received signal and local oscillator are phase-locked to each other. If this state of homodyne tracking is reached, communication can be started.

Spatial acquisition is the process of co-aligning the receiver line of sight and the transmit-beam of the optical communication terminal precisely with the direction of the counter terminal’s position. If the direction of the counter terminal is known to a sufficient degree of precision, co-alignment can be achieved by pointing the terminal to the known direction by direct open-loop pointing. The estimated error on the counter terminal direction is called an ‘Uncertainty Cone’ (UC) and is available (usually) to a precision of a few milliradians. A constant of the propagation of electromagnetic waves is the so-called beam parameter product. For near-infrared light, the beam parameter product is in the order of \sim mm mrad. As it is beneficial for the link budget to maximize the communication beam aperture, the UC of the terminal is often orders of magnitude larger than the beam divergence of the communication beam. Thus a direct open-loop pointing is in many cases not feasible, leading to reliance in the acquisition process on an optical feedback signal to which the counter terminal can align. Either an additional beam with a beam divergence larger than the communication beam (a so-called beacon) is employed for this purpose, or the communication beam with small beam divergence scans the UC to provide the necessary feedback to the counter terminal. Literature distinguishes between acquisition with beacon and beaconless acquisition if only the communication signal is employed to achieve spatial acquisition, either by direct pointing or scanning.

In beacon-based systems, a 2-D sensor is utilized to detect and center the beacon signal. Mechanical co-alignment of the pixel and communication sensors’ coordinate systems needs to be guaranteed in space over a wide range of operating temperatures, which guarantee requires a balance between mechanical stability and light-weight construction. Quadrant photodiodes are an alternative design option, which can be used simultaneously as a receiver for acquisition and for communication. Avoiding pixel sensors has the advantage of reduced power and mass, and higher reliability since the part count is lower and quadrant photodiodes have better FIT rates than pixel sensors. If the wavelength of the beacon differs from the communication beam, then the optical system (e.g., coatings) has to be optimized for both wavelengths, which results in compromises and reduces system performance for the communication wavelength. The higher divergence of a beacon laser requires higher optical transmit power than a beaconless system, which increases the requirements of the system to cope with high optical power densities. For example, keeping receive-signal power constant,

transmit power has to be 100 times higher if the beacon divergence is 10 times higher than the beaconless transmit beam, which increases the optical power from 0.7W to 70W for a LEO-LEO system.

Before designing a specific Pointing, Acquisition, and Tracking (PAT) scheme, it is important in any case to analyze and, if possible, to reduce the UC of the link. If a link is to be established between two different terminals, the link acquisition will be influenced by two main factors:

The first factor to be considered is the so-called Host Uncertainty Cone (HUC), which is derived from the position, attitude, and timing knowledge of the transmitting optical terminal. To determine the second factor, the so-called Total Uncertainty Cone (TUC), the position uncertainty of the receiving counter terminal, also needs to be taken into consideration.

Parameters that influence HUC and TUC and are recommended to be optimized for mission planning of optical links in context, for example, of an ICD are the following:

a) Timing accuracy

The precision of timing data determines how well the position of terminal and counter terminal are known.

b) Position knowledge

Depending on the location of the terminal (e.g., Earth, geostationary S/C, low orbit Earth observation S/C), the accuracy of position knowledge will differ. The position accuracy directly influences the size of the UC.

c) Attitude knowledge

Precision of the knowledge of orientation in space directly influences the size of the UC. To determine the attitude knowledge, internal contributors such as pointing precision of the Optics and external contributors such as alignment knowledge aboard a S/C and attitude knowledge of a S/C have to be determined.

d) (Micro)-vibration

In-orbit vibration is to be considered in the design of the beaconless spatial acquisition algorithm, so that spatial-acquisition probability and spatial-acquisition duration requirements are met. The design of the algorithm depends on the magnitude and frequency of vibrations.. The greatest contributors to in-orbit vibrations are reaction wheels and solar arrays. The design of the beaconless spatial acquisition algorithm is based on the predicted in-orbit vibration of both S/Cs, and therefore the performance of the algorithm depends on the in-orbit vibration conditions of not only the local S/C but of the counter S/C as well.

e) Planning cycle and telecommand opportunities

The precision of position knowledge may depend on the link planning cycle, since the position knowledge will degrade over time. The longer the planning cycle, the more safety margins have to be applied to counterbalance increasing TUC. Predicted S/Cs positions on ground are also used to inform the optical terminal where the counter terminal is at the time of a requested data transmission. The error of the predicted terminal position can be kept small using updated predictions.

2.3.2 ACQUISITION SEQUENCE

2.3.2.1 Introduction

The following beaconless PAT scheme is implemented in the EDRS and has previously been reliably verified in orbit with the TerraSar-X NFire optical LEO intersatellite links. It uses the communication beam (i.e., identical wavelength and beam divergence as the communication signal) and scans the UC to achieve spatial acquisition. Because of the scanning methodology, a time-tagged sequence has been chosen. Additionally, the transmitted beam is modulated to facilitate terminal identification and to improve the PAT link budget. To establish a link acquisition with the EDRS optical terminals, only the normative characteristics of the optical signal (wavelength, modulation, etc.—see below) are required. However, the knowledge of the time-tagged acquisition sequence is helpful and recommended to be agreed upon in a mission-specific ICD.

2.3.2.2 Beaconless PAT

In the first phase of the time-tagged PAT sequence, both optical terminals point in the estimated direction of their respective counter terminal in open loop. The estimated direction needs to be known, with limited accuracy, of the total UC, which will typically be in the order of milliradians; larger UCs increase the duration of the spatial acquisition. After initial open-loop pointing, the spatial acquisition starts in master-slave mode. The master and slave roles are determined during mission planning. The master optical terminal emits light and spirals the UC with its low divergent transmit beam, and the counter (slave) Laser Communication Terminal (LCT) should receive a light pulse once per scan. The receiving optical terminal in slave mode will successively reduce its UC with each light pulse, as it corrects its pointing with each received light pulse with a decreasing step size. Because of vibrations, the probability of hitting the counter terminal might be below 100 percent for a single scan.

After a predefined number of scans, the master terminal stops scanning and transmitting. The number of necessary scans depends on overall system characteristics, which define the total UC.

The slave terminal is at this point well aligned to the master terminal, and the roles of master and slave are reversed: the former slave terminal takes on the role of master and starts to scan

the remaining UC. Since the UC is small during this second phase of acquisition, much shorter single scans allow the former master terminal (now slave) to align quickly by the same algorithm. At a predefined fine alignment—the remaining UC may be defined in the context of mission-specific ICDs—the former master also restarts to emit light and to scan. Both terminals are now scanning the UC while reducing the scan angle from scan to scan. The alignment is further improved until the tracking sensor responds. The terminal then stops scanning and stably tracks its counter terminal. At this point in time, spatial tracking is accomplished. Figure 2-2 shows a simplified flow chart of the beaconless spatial acquisition algorithm.

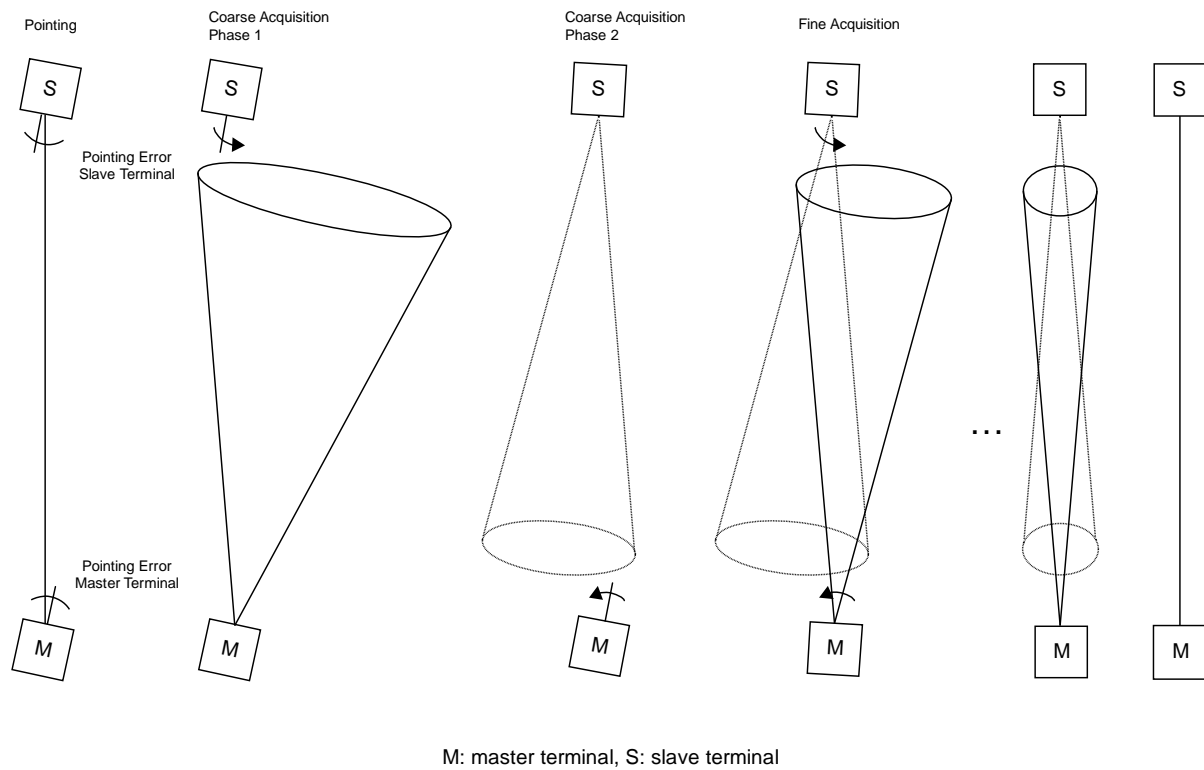

Figure 2-2: Modes of Beaconless Acquisition According to a Master-Slave Approach

Figure 2-3 shows a simplified flow chart of the beaconless spatial acquisition algorithm.

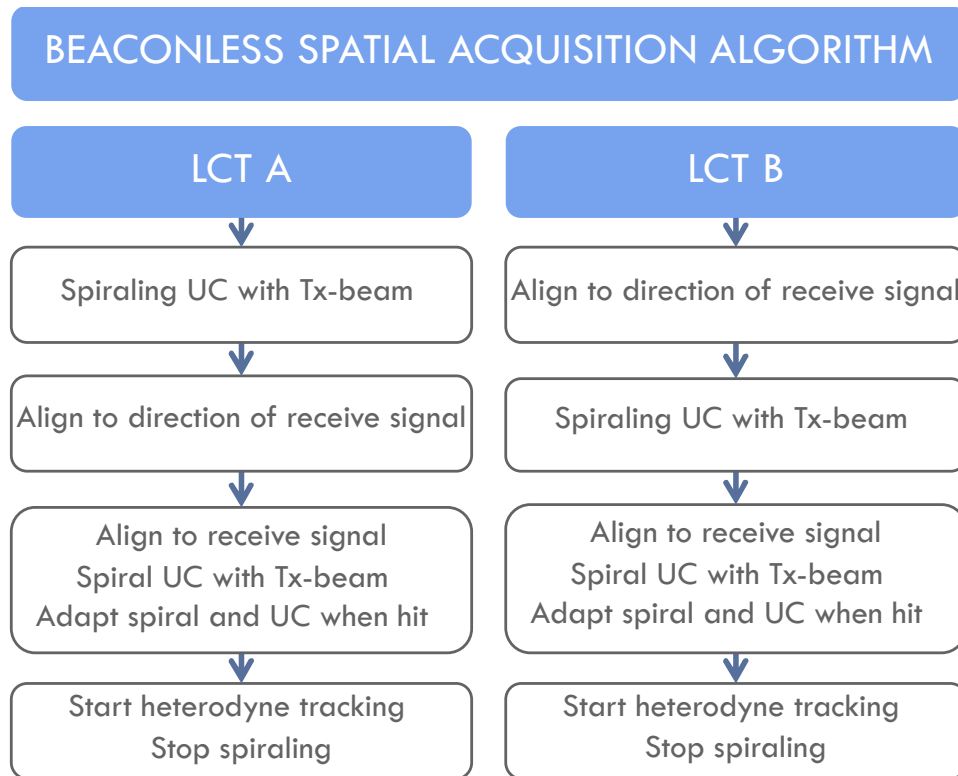

Figure 2-3: Simplified Flow Chart of the Beaconless Spatial Acquisition Algorithm

The acquisition sequence then continues to achieve homodyne tracking by performing frequency acquisition. The laser frequencies of the respective local oscillators must be adjusted so they are phase-locked to the received signal. Each terminal is now coherently phase locked to the counter terminal; homodyne tracking is thus achieved and the terminals are ready to initiate communication.

2.3.3 ACQUISITION TIME

For the beacon-less acquisition method, the acquisition time is a time-tagged parameter. It is recommended to agree on the acquisition time within the context of an ICD, as it will depend strongly on the mission scenario. Determining factors for the acquisition time are the size of the total UC of the link. Based on the size of the UC, a trade-off between reliable link acquisition and fast acquisition will be done. In a highly dynamic LEO-LEO intersatellite link, configuration acquisition times of 8 s (and in specific cases, 2 s) have been demonstrated in orbit. For UCs of 1 milliradian, acquisition times of 55 s are guaranteed for the EDRS intersatellite and ground link (including a safety margin). In actuality, smaller acquisition times can be expected after initial in-orbit verification.

2.4 DATA LINK LAYER

2.4.1 TERMINAL A DATA LINK LAYER CHARACTERISTICS

2.4.1.1 General Layer Structure

The description of the coding and synchronization schemes for optical communication is compliant with the CCSDS layer structure as stated in 2.2 of this document.

2.4.1.2 Application Examples

Figure 2-4 displays an example of how the optical communication is embedded in a satellite network. The example is based on the EDRS, with which data is transmitted over an Optical Inter-Satellite Link (OISL), from a LEO satellite via laser to a GEO relay satellite, and from Relay to Ground via RF links. The communication is bidirectional, at least on the OISL (the uplink from ground to GEO is outside the scope of this document). Both LEO and GEO satellites contain one LCT each.

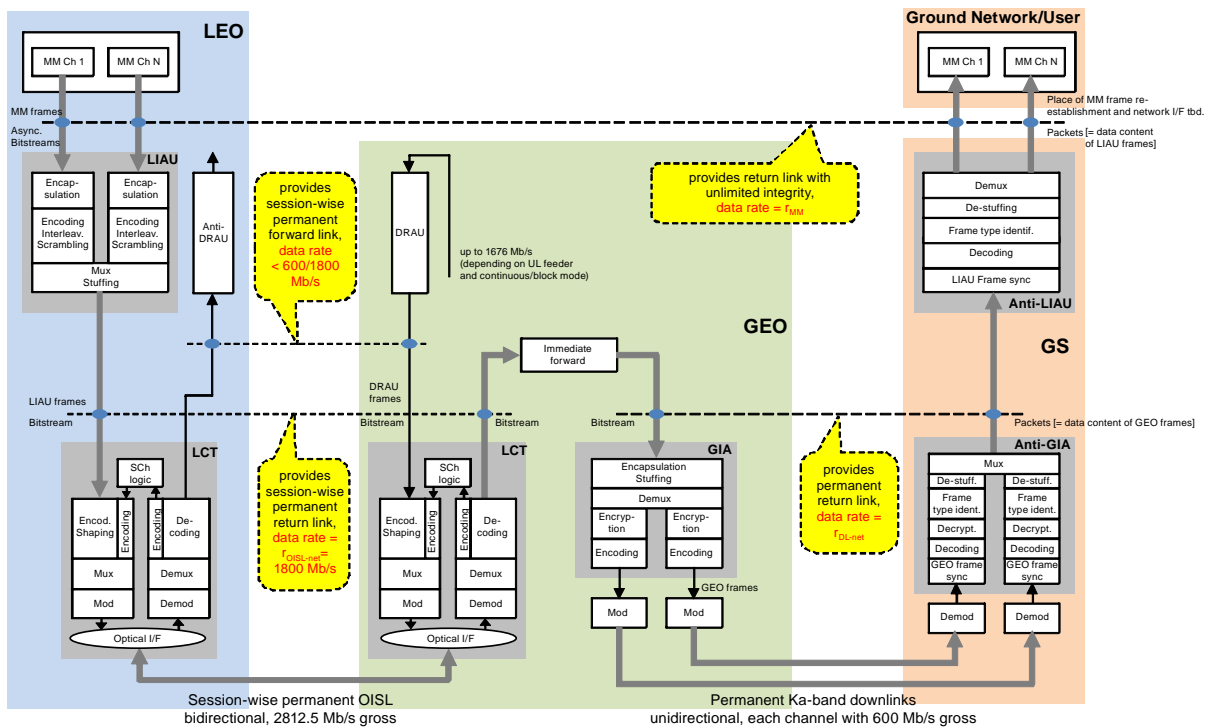

Figure 2-4: Layer Overview for the Example of EDRS Application

As shown in figure 2-4, the data stream is not fed directly into the LCT:

- On the LEO satellite, the data from the source(s), also denoted as mass memory (MM), is fed into a device denoted as an LCT Interface Adaptation Unit (LIAU). This is called return service. The reverse counterpart to LIAU is denoted as Anti-LIAU (located on ground, but this is not relevant in this context).

- On the GEO satellite, the data to be transmitted as forward service is fed into a device denoted as Data Rate Adaptation Unit (DRAU). The reverse counterpart to DRAU is denoted as Anti-DRAU and is located in the LEO satellite.

The term LIA (LCT Interface Adaptation) is used here as a generic term for both LIAU and DRAU; the generic term for the reverse units is Anti-LIA.

It should be noted that the LIA accepts CCSDS frames as input data, but does not actually demand a specific formatting of the input data, as the LIA and Anti-LIA transparently encapsulate any input data for transport over the optical link, regardless of the source data format (e.g., raw mass-memory dumps or CCSDS frames).

The LCTs on LEO and GEO are denoted here as type A and type B, respectively. Typically, there is LIA=LIAU for type A and LIA=DRAU for type B, but in order not to exclude other scenarios, and for the sake of simplification and generality, a more general architecture for LIA is specified.

As a general principle, a lower layer provides a service to the layer above via a Service Access Point (SAP). The lower layer should be independent, as much as possible, from the higher layer. The term ‘layer’ does not exactly reflect the original OSI meaning, since all ‘layers’ mentioned here are basically Physical and Data Link Layers in the OSI sense.

For the sake of layer independence and technology independence, any data structures present in the input signal to LIA are ignored, and the input data is encapsulated into frames (known as bitstream service from CCSDS 732.0.B-3, subsection 3.4—reference [5]).

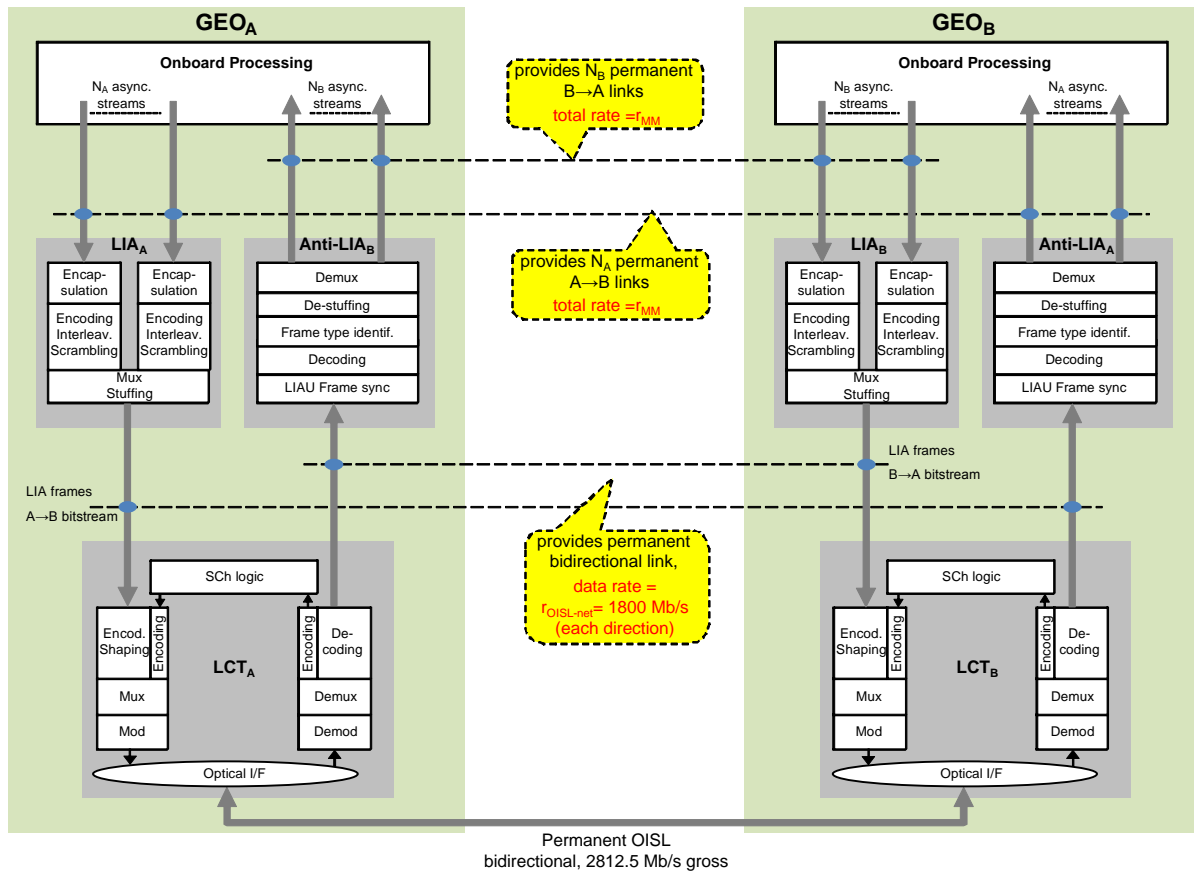

Figure 2-5: Layer Overview for the Example of a Symmetrical OISL between Two GEO Relays

In figure 2-5, an OISL between two GEO relays is considered as a further example, in which a fully symmetrical relation between both satellites is assumed. N_A independent and asynchronous links are supported from A to B. Vice versa, N_B independent and asynchronous links are supported from A to B. Of course, N_A and N_B could be equal to 1 and LIA/Anti-LIA functions could be physically integrated into the ‘Onboard Processing’ block.

The next two figures display the EDRS satellite network architecture in terms of block diagrams. This information is provided for a better overview and to introduce reference points and data rates.

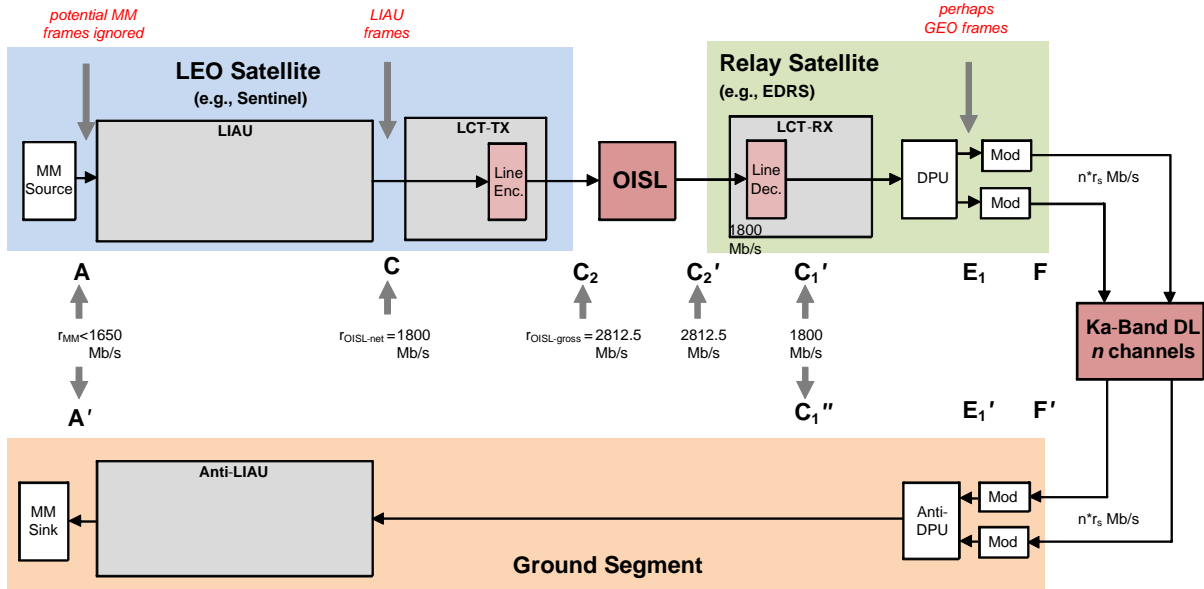

Figure 2-6: Block Diagram with Reference Points and Data Rates for the Example of EDRS Application

Figure 2-6 shows the EDRS application with maximum data rates.

NOTE – As shown in the figure 2-7, there are also other EDRS applications in which the throughput on the DownLink (DL) from Relay to Ground is limited to a net value of 600 Mb/s. It is possible to design the LIAU frames with a reduced header (of 2 bytes only instead of 8 bytes) such that the combination of $r_{MM}=560$ Mb/s and $r_{DL-net}=600$ Mb/s is supported. This mode is called ‘throughput optimized’ (also denoted as 600 Mb/s mode or Sentinel mode) and is included here to demonstrate the flexibility of the concept. However, the reduced header of 2 bytes is not possible for all cases.

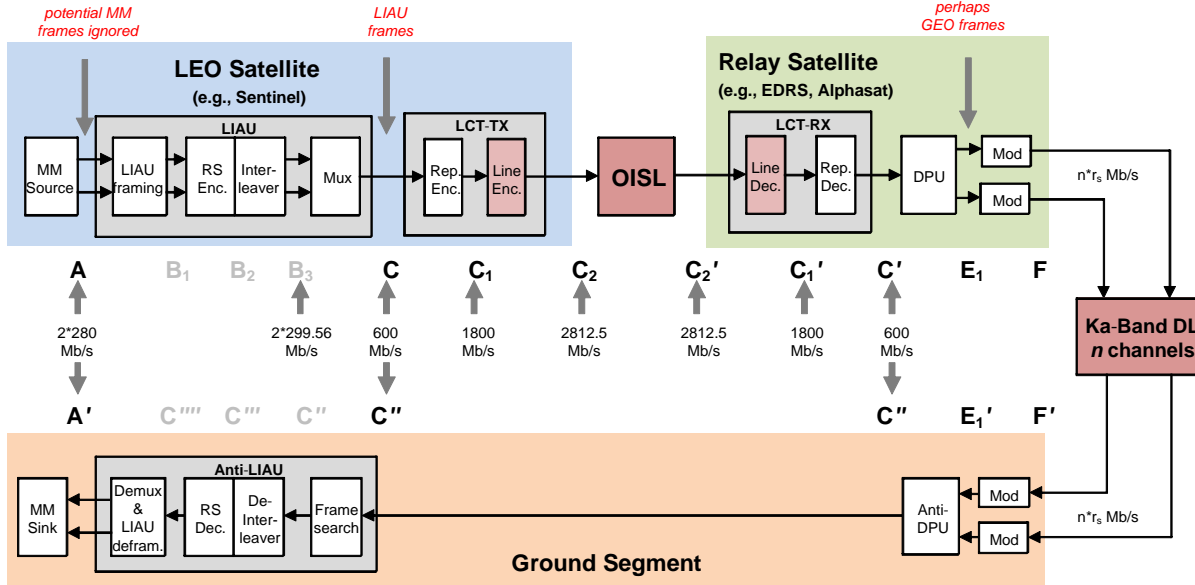

Figure 2-7: Block Diagram with Reference Points and Data Rates for the Example of EDRS Application with Optimized Throughput (Denoted As 600 Mb/s Mode or Sentinel Mode)

The most important reference points from the two figures above are summarized below (all data rates mentioned below refer to the current LCT technology):

- A is the interface between source (MM) and LIA=LIAU. The maximum data rate r_{MM} is limited to a value slightly below 1800 Mb/s; for example, $r_{MM} = 1676$ Mb/s, denoted as *user data rate* or *MM data rate*. The corresponding interface on the receiver side is denoted ‘A’.
- C is the (internal) interface between LIA and LCT. The data rate here is always exactly $r_{OISL-net} = 1800$ Mb/s (or an integer multiple of $112.5 = 1800/16$ Mb/s), denoted as *OISL net data rate*. The corresponding interface on the receiver side is denoted ‘C’.
- C₂ is the ‘space (air)’ interface between the LCTs, including all overhead for coding and synchronization and control. The data rate here is always exactly $r_{OISL-gross} = 2812.5 = 1800 \times 25/16$ Mb/s, denoted as *OISL gross data rate*. By definition, a corresponding interface on the receiver side does not exist.

NOTES

- 1 For LIA=LIAU, the maximum user data rate @ A is in the order of 560 Mb/s, and the net OISL data rate @ C is 600 Mb/s (or an integer multiple of $37.5 = 600/16$ Mb/s). However, the gross OISL data rate @ C₂ is always 2812.5 Mb/s.

- 2 For LIA = DRAU and the EDRS example, the data rate at the input to DRAU is very small (in the order of some kb/s), and the OISL net data rate is 112.5 Mb/s.

In summary, for the EDRS application with 600 Mb/s, LIA=LIAU on the LEO satellite and LIA=DRAU on the GEO satellite are different. For all other cases (like EDRS with 1800 Mb/s or the GEO-GEO link), a general concept for LIA is specified with no need to distinguish between different applications.

2.4.1.3 Objectives for LIA Design

The objectives for the LIA design are summarized as follows:

- main functions/output side (I/F to LCT):
 - usage of the 1800 Mb/s mode of the LCT ($r_{OISL-net} = 1800$ Mb/s);
 - user-data rate as high as possible—but with support of
 - enhanced coding gain together with LCT internal coding,
 - adaptation (fix or variable) to μ W-feeder DL capabilities;
 - compatibility with EDRS relay and DTE setups and minimized footprint on relay;
 - support of robust receiver operation;
- main function / input side (I/F to mass memory):
 - support of 1... N data streams (multiplexing prior to or within LIA);
 - support of variable (or switch on/off) data rates;
 - support of LIA=LIAU integration into mass memory;
 - support of unconstrained user-data integrity;
 - additional requirements (e.g., very small data rates);
- clock concept:
 - LIA to clock LCT-TX;
- LIA clock is available in LCT-RX. In case of LIA=LIAU, it can be either terminated (like EDRS) or forwarded (like Alphasat) in the relay satellite; conformity to CCSDS data processing schemes as far as possible.

2.4.2 DISCUSSION

Figure 2-8 shows more details for the support of DL channels with variable throughput. The basic idea is summarized as follows:

The input data rate from MM to LIA is reduced to a value such that after addition of overhead (because of LIA encapsulation and frame structure), the resulting data rate does not exceed the DL throughput.

Stuffing with LIA idle frames is required in LIA to achieve the fixed throughput rate on the OISL. This stuffing needs to be removed in the Relay satellite (this is somehow a footprint on GEO; details are outside the scope of this document).

If the available data rate from MM is even lower than the capacity of the DL, further stuffing is required. Hence, a part of the LIA idle frames has to be removed in GEO, and another part has to be transmitted in DL (to minimize the footprint on GEO, LIA can introduce two types of idle frames).

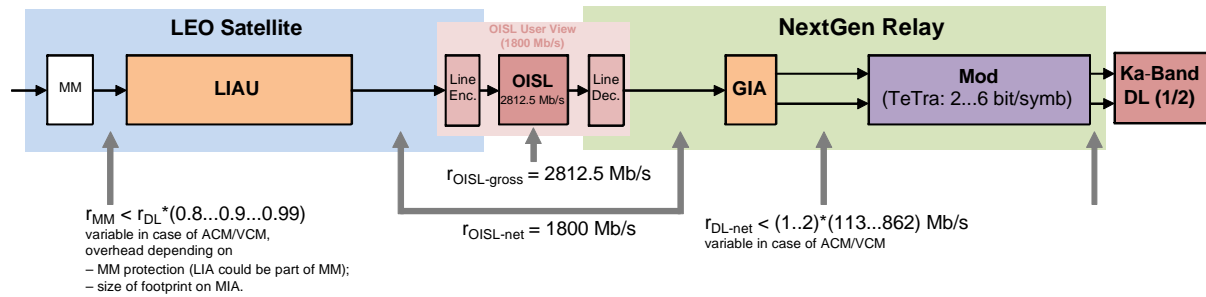

General Considerations

- If the TeTra modulator is used with VCM/ACM to adapt to propagation conditions (e.g., rain, elevation):
 - r_{DL-net} is variable (selectable @ VCM, adaptive @ ACM);
 - r_{MM} is variable.
- OISL throughput is large enough to feed up to two TeTra DLs with 216 MHz (see below for exceptions).
- OISL throughput is fixed (to $r_{OISL-net} = 1800 \text{ Mb/s} > r_{DL-net}$):
 - stuffing in LIAU is required;
 - de-stuffing in GIA is required → LEO leaves a footprint in MEO.
- Split of data to 2 DL channels in GIA → Framing is required, preferably together with stuffing in LIAU → Again, footprint in MEO.
- Option: LIAU and MM could be integrated into one box.

Conclusions on LIAU Overhead

- Minimal overhead in LIAU is to be added for framing (framing enables stuffing in LIAU and split in GIA).
- More overhead in LIAU is to be added for OISL protection if not done in MM.

Figure 2-8: Requirements on LIA=LIAU for Flexible Relay Network

In summary, LIA frames and the concept of encapsulation are introduced for coding purposes (to enhance the link budget margin of the OISL) and for flexibility purposes (the stuffing concept does allow for the transmission of arbitrary user data rates over a link with fixed data rates).

The following subsections describe the specification of the LCT Interface Adapter (LIA).

2.5 ARCHITECTURE OF LIA

The general architecture of the LIA is displayed in the figure 2-9.

A number of N sources (mass memories) are connected to LIA on the input side, and a data stream of $r_{OISL-net} = 1800$ Mb/s is created on the output side. If the incoming data stream has a frame structure like LIA frames, this structure is fully ignored in LIA.

Examples are $N=1$ for LIA=DRAU or $N=2$ for LIA=LIAU. The upper bound for N is given by the implementation only, but a general limit does not exist (however, the recommended LIA header provides 6 bits for the source ID, so 64 different sources can be distinguished).

The N inputs can have independent time-variant data rates (including on-off operation), supposing the aggregate rate is limited:

$$\begin{aligned} \text{aggregated LIA input rate} &= r_{MM} < r_{OISL-net} \times 1904/2044 \\ &= 1676 \text{ Mb/s (for } r_{OISL-net} = 1800 \text{ Mb/s).} \end{aligned}$$

The data rate at the output is always constant with $r_{OISL-net} = 1800$ Mb/s, even in cases in which all inputs sources are inactive with $r_{MM} = 0$.

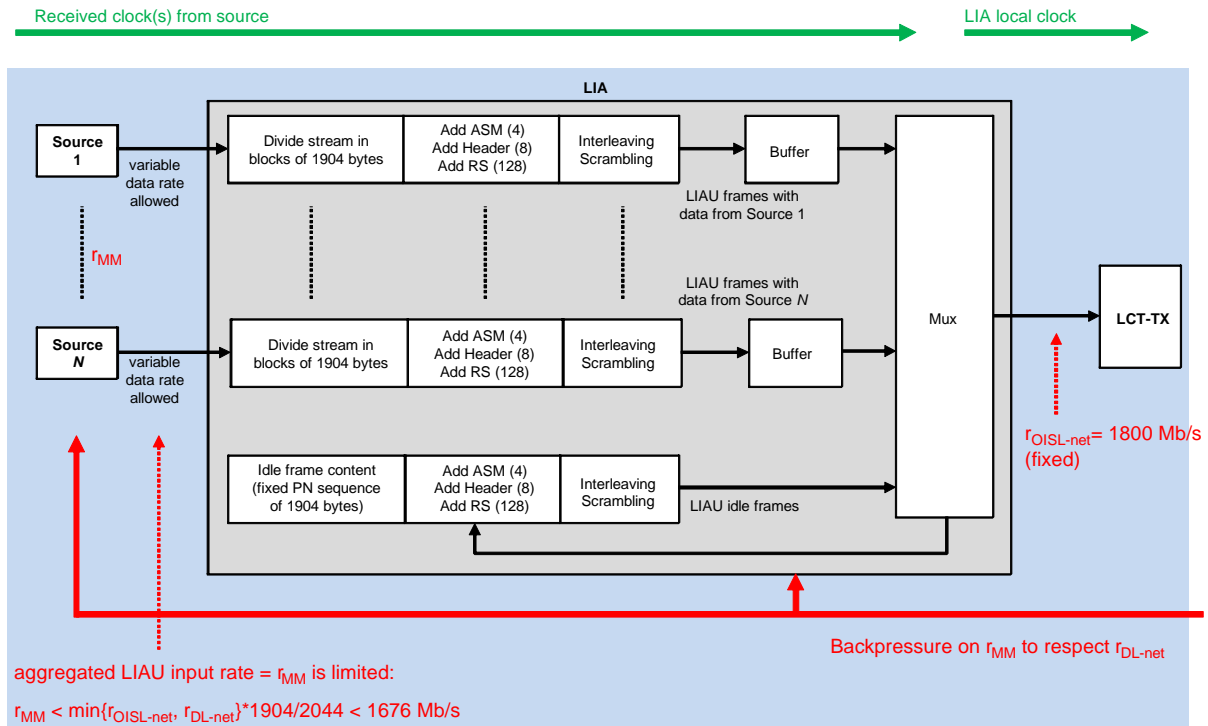

Figure 2-9: Architecture of LIA

As shown in the figure 2-9, the input data streams are divided (packetized) in data blocks. These data blocks are equipped with a frame header. Then the concatenated field [data block, frame header] is together encoded with an R-S code, followed by interleaving and scrambling. The N chains are operated independently and asynchronously.

Another chain produces idle frames, as many as required, to generate at LIA output a constant data rate of $r_{OISL-net} = 1800$ Mb/s. The multiplexer operates on $N+1$ chains, where the first N chains are served on a first-come-first-transmit basis, and the idle frames from the last chain have lowest priority (i.e., are inserted and transmitted only to increase the data rate to $r_{OISL-net}$). This is denoted as a stuffing operation.

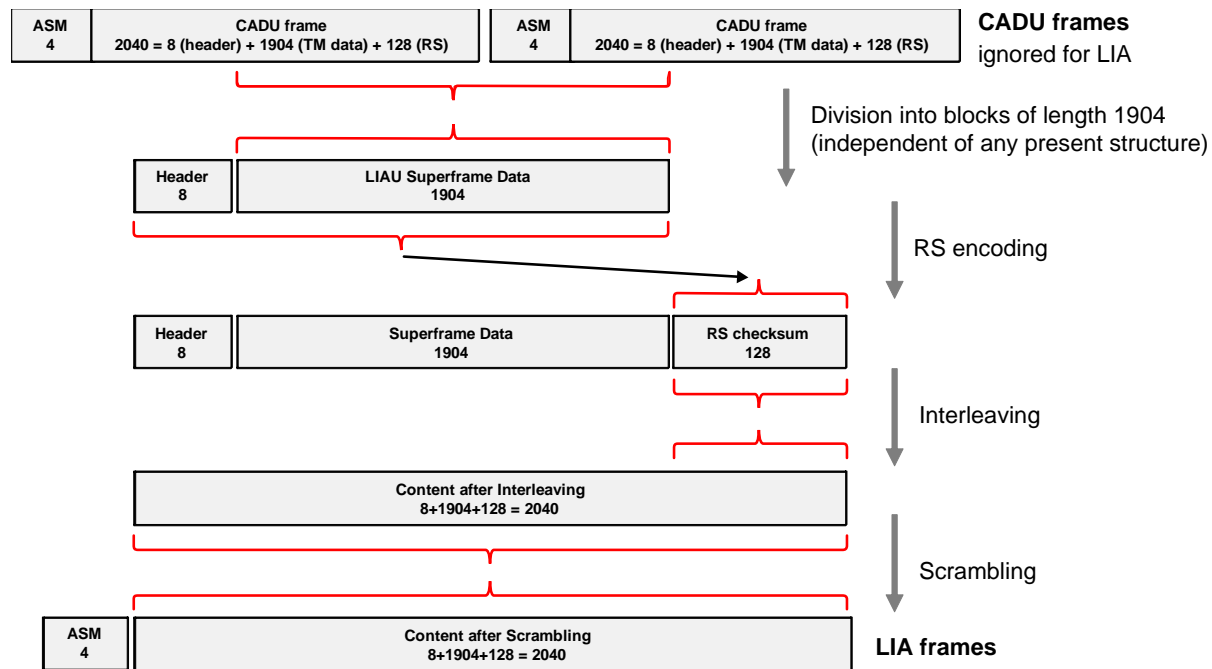

Figure 2-10: Sequence of Operations in LIA for Framing

The figure 2-10 shows the sequence of operations to build up a LIA frame. The structure of the incoming data stream is fully ignored, and the data stream is divided into blocks of 1904 bytes (a byte structure of the incoming data shall be observed). Then a header of 8 bytes is added resulting in $1904+8=239 \times 8$ bytes, corresponding to 8 codewords of an R-S(255,239) code, in accordance with section 4 of reference [2]. The R-S parity symbols with a total length of $8 \times (255-239)=128$ bytes are added. The resulting packet of 2040 bytes is interleaved and scrambled. Finally, an Attached Synchronization Marker (ASM) word of 4 bytes is added.

The concept of backpressure is described in more detail in the figure 2-11.

Adaptation to available data rate in μ W-DL

- Basic idea:
 - The source (or the aggregated sources) is commanded to present data with a limited rate to the LIAU
→ Backpressure from μ W-DL to MM
 - The LIAU generates a data rate of 1800 Mb/s by stuffing with idle frames
 - The GEO relay removes the stuffing (partly) to reduce the data to the net rate of the μ W-DL
- Note: this leaves a footprint of the LIAU on the GEO relay (drawback!)
 - The GEO relay has to detect the LIAU frame structure
 - The GEO relay has to remove the LIAU idle frames

Details

- Net rate of μ W-DL = r_{DL-net} [Mb/s]
- Each source @ LIAU input may have different and time-variant data rate, but rMM shall be bounded as
Aggregated LIAU input rate = $r_{MM} < \min\{r_{OISL-net}, r_{DL-net}\} \times 1904/2044$ Mb/s
- Several alternatives/modifications are possible (see below)
- Alternatives for idle frame extraction in GEO relay
 - Remove LIAU idle frames automatically as much as needed
 - Introduce two types of idle frames in LIAU, one for extraction in relay and one for stuffing in LIAU
 - GEO relay may introduce additional frame structure for coding purposes or for clock termination

Figure 2-11: Backpressure Concept for LIA=LIAU to Adapt to Given Data Rates on RF Downlink

3 PHYSICAL LAYER

3.1 TERMINAL A OPTICAL TRANSMIT SIGNAL CHARACTERISTICS

3.1.1 OVERVIEW

Optical transmit signal characteristics are valid for coarse and fine spatial acquisition. For tracking, communications signal characteristics apply (direct detection on acquisition sensors, but coherent detection on tracking sensor).

3.1.2 CENTER FREQUENCIES

The center frequency shall be equal to 281594.0 GHz \pm 3 GHz.

NOTE – During the spatial acquisition process, there are no specific requirements for the Laser Tuning Range, Laser Tuning Range Rate, Laser Line Width, Laser Relative Intensity Noise, Laser Frequency Noise, and Laser Phase Noise.

3.1.3 POLARIZATION

3.1.3.1 Polarization Type

The transmit beam shall have a Left-hand Circular Polarization (LCP), where the E-vector rotates counter-clockwise as viewed from the transmitter in the direction of propagation.

3.1.3.2 Polarization Extinction Ratio

NOTE – While there is no specification of the polarization extinction ratio as such, the minimum irradiance levels refer to the nominal polarization state.

3.1.4 MODULATION

3.1.4.1 Modulation Scheme

During spatial acquisition, the transmit signal shall be amplitude modulated with a frequency of 1.0045 MHz \pm 200 ppm and a modulation index higher than 95 percent.

3.1.4.2 Spectral Mask (LPC) Pulse Shape

The modulation waveform shall be sinusoidal.

NOTE – There are no special requirements for the Symbol Synchronization.

3.2 TERMINAL B OPTICAL SIGNAL CHARACTERISTICS

3.2.1 CENTER FREQUENCIES

The center frequency shall be equal to 281566.0 GHz \pm 3 GHz.

NOTE – Same as Terminal A. There are no specific requirements for Laser Tuning Range, Laser Tuning Range Rate, Laser Line Width, Laser Relative Intensity Noise, Laser Frequency Noise, and Laser Phase Noise.

3.2.2 POLARIZATION TYPE

The transmit beam shall have a Right-hand Circular Polarization (RCP), where the E-vector rotates clockwise as viewed from the transmitter in the direction of propagation.

NOTE – This is the same as Terminal A. There are no special requirements for Polarization Extinction Ratio.

3.2.3 MODULATION

3.2.3.1 Modulation Scheme

During spatial acquisition, the transmit signal shall be amplitude modulated with a frequency of 1.7578 MHz \pm 200 ppm and a modulation index higher than 95 percent.

3.2.3.2 Spectral Mask (LPC) Pulse Shape

The pulse shape shall be the same as Terminal A.

NOTE – There are no specific requirements for Symbol Synchronization, Pulse Repetition Rate, and Extinction Ratio.

3.3 COMMUNICATIONS SIGNAL

3.3.1 BAND PLAN

NOTE – A Band Plan is not specified because it is not applicable to this Experimental Specification.

3.3.2 TERMINAL A OPTICAL COMMUNICATIONS SIGNAL CHARACTERISTICS

3.3.2.1 Center Frequencies

3.3.2.1.1 General

The center frequency shall be equal to 281594.0 GHz \pm 3 GHz.

3.3.2.1.2 Laser Tuning Range

The TX laser shall be tunable within a range of \pm 10 GHz.

NOTE – The tunability serves to compensate the Doppler shift.

3.3.2.1.3 Laser Tuning Range Rate

The maximum laser tuning range rate shall be 120 MHz/s in communication mode.

3.3.2.1.4 Laser Line Width

The unmodulated TX laser shall have a line width of less than 100 kHz over a time scale of 100 msec.

3.3.2.1.5 Laser Relative Intensity Noise

The TX laser Relative Intensity Noise (RIN) shall be less than -30 dB in the frequency range between 0.01 Hz and 3 GHz.

3.3.2.1.6 Laser Frequency Noise

The frequency noise of the free running TX laser shall be less than the limit defined in figure 3-1.

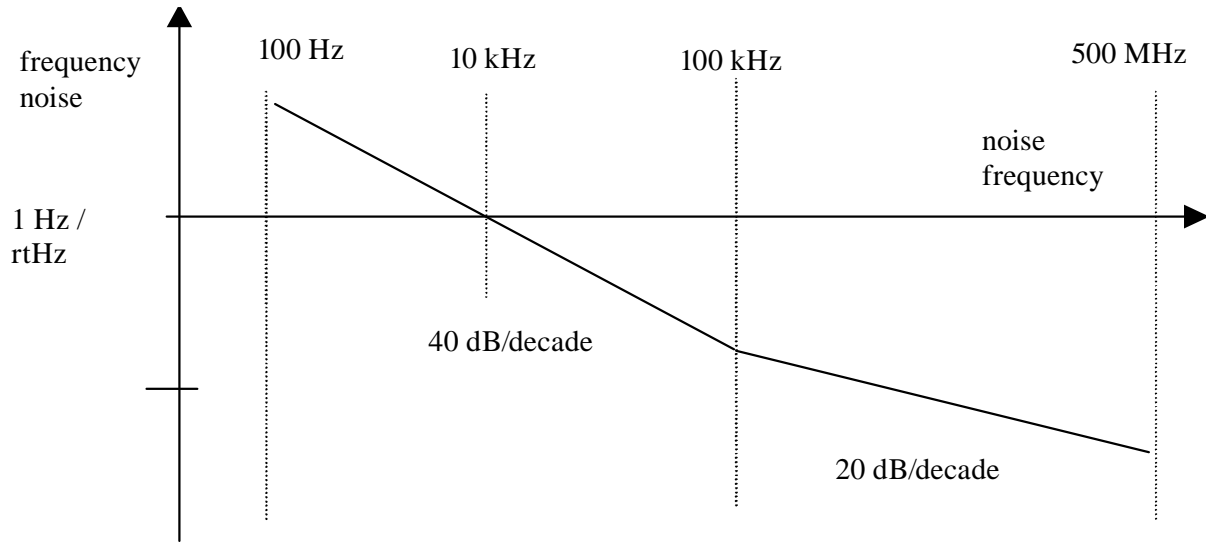

Figure 3-1: Upper Limit for the Frequency Noise of the Tx Laser

3.3.2.1.7 Laser Phase Noise

The change rate of the laser phase noise ($\Delta\phi/\Delta t$) shall be less than 6400 rad/s.

3.3.2.2 Polarization

3.3.2.2.1 Polarization Type

The transmit beam shall have an LCP, where the E-vector rotates in a *counter*-clockwise direction as viewed from the transmitter in the direction of propagation.

3.3.2.2.2 Polarization Extinction Ratio

NOTE – While there is no specification of the polarization extinction ratio as such, the minimum irradiance levels refer to the nominal polarization state.

3.3.2.3 Modulation

3.3.2.3.1 Modulation Scheme

The modulation scheme shall be BPSK with Non-Return to Zero (NRZ). The nominal symbol rate shall be 2812.5 Megasymbols/sec (Ms/s).

3.3.2.3.2 Symbol Synchronization, System Channel, and Spectral Shaping (LPC)

3.3.2.3.2.1 Mux and Align

The Mux and Align mode adaptation block is the interface to incoming code symbol units (in case a LIA/LIAU is implemented) or user data bits (when directly supplied to the LPC), respectively. For ease of nomenclature, incoming code symbols are assumed in table 3-1. The block works on parallel data units of 1 to 16 symbols/bit. The recommended numbers of parallel data units are 8 and 16.

Table 3-1: Mux and Align Modes

Mode	Bit	Word Rate [Mb/s]	Bitrate [Mb/s]	
1	N	37.5	$N \times 37.5$	General Low Rate
2	8	37.5	300	Recommended
3	16	37.5	600	Recommended
4	N	112.5	$N \times 112.5$	General High Rate
5	8	112.5	900	Recommended
6	16	112.5	1800	Recommended

NOTE – On the optical Physical Layer, the bit rate is always 2812.5 Mb/s (see 3.3.2.3.1).

3.3.2.3.2.2 Mode 1: $N \times 37.5$ Mb/s User Data Transmission Mode

The mapping of $DatIn[N:0]$ to the inputs of the parallel scrambler, $ScrIn[24:0]$, shall be $ScrIn[23:N+1] = 00_{HEX}$ and $ScrIn[N:0] = DatIn[N:0]$.

In order to adapt the input clock rate to the output clock rate, each channel bit of $DatIn[N:0]$ shall be repeated three times. That is, every sample of $DatIn[N:0]$ shall be triplicated to a 3-tuple $DatIn[N:0]_1$, $DatIn[N:0]_2$ and $DatIn[N:0]_3$. These 3-tuples shall be aligned to the scrambler reset in such way that the initialized scrambler always operates on $DatIn[N:0]_1$ (cf. figure 3-7).

NOTE – When in 37.5 Mb/s operation mode, the user data rate is reduced by sending the same user data three times over the optical link; that is, the user data is triplicated on the transmit side. Triplication is not performed on system channel data, but only for user channels 0 to 15.

The reset period for the scrambler of 4095 system channel frames has been chosen in order to make it a multiple of three channel bit durations. Therefore it is possible to align the 3-tuples of identical samples in a way that enables the receive side to group the 3-tuples correctly, to allow a majority vote.

3.3.2.3.2.3 Mode 4: $N \times 112.5$ Mb/s User Data Transmission Mode

In the $N \times 112.5$ Mb/s mode N channels $DatIn[N:0]$ carry user data.

The mapping of $DatIn[N:0]$ to the inputs of the parallel scrambler, $ScrIn[24:0]$, shall be $ScrIn[23:N+1] = 00_{HEX}$ and $ScrIn[N:0] = DatIn[N:0]$.

3.3.2.3.3 Scrambler

3.3.2.3.3.1 The scrambler shall provide a Pseudorandom Binary Sequence (PRBS) generator with 25 stages named $X[24:0]$.

NOTE – The Scrambler produces the same PRBS as a shift register with feedback according to the following equation:

$$X[0](t'+1) = X[21](t') \oplus X[24](t')$$

where $\oplus = \text{XOR}$, and t' indicates the time index for bit-shifts.

The time index t' differs from the time index t in equation (1), since t' refers to the bit-serial implementation of the scrambler, while t refers to the parallel implementation. A serial scrambler would have to run 24 times faster than the equivalent parallel scrambler and thus t' corresponds to $t/24$.

3.3.2.3.3.2 The scrambler shall process all 24 input bits $ScrIn[23:0]$ within one clock cycle. Therefore a parallel PRBS generator that performs 24 steps of the equivalent serial PRBS generator within one clock cycle must be implemented according to the following scheme:

$$\begin{aligned} X[0](t+1) &= X[1](t) \oplus X[20](t) \oplus X[23](t) \\ X[0](t+1) &= X[2](t) \oplus X[21](t) \oplus X[24](t) \\ X[24](t+1) &= X[0](t) \end{aligned} \tag{1}$$

$$X[n](t+1) = X[n-2](t) \oplus X[n+1](t) \quad \forall n \in \{2, 3, \dots, 23\}$$

where $\oplus = \text{XOR}$ and t indicates the time index.

3.3.2.3.3.3 The data bits $ScrIn[23:0]$ shall be processed by applying the following scheme in equation (2).

$$LPCEncIn[23:0] = ScrIn[23:0] \oplus X[0:23]$$

or explicitly:

$$\begin{aligned} LPCEncIn[23] &= ScrIn[23] \oplus X[0] \\ LPCEncIn[22] &= ScrIn[22] \oplus X[1] \\ &\vdots \\ LPCEncIn[1] &= ScrIn[1] \oplus X[22] \\ LPCEncIn[0] &= ScrIn[0] \oplus X[23] \end{aligned} \quad (2)$$

NOTE – Table 3-2 shows how the initial register contents B0 to B24 are processed and shifted through a serial PRBS generator as defined above. The row for time step $t' = 24$ (i.e., $t = 1$) shows the register contents of the PRBS generator after 24 time steps t' and therefore defines the building rule for the parallel implementation of the PRBS generator.

Time steps t' do not correspond to system clock cycles but only help to illustrate the building rule for the parallel implementation of the scrambler.

Table 3-2: Illustration of the Building Rule for the Parallel PRBS Generator

Time Step		X[0]	X[1]	X[2]	...	X[21]	X[22]	X[23]	X[24]
t'	t								
0	0	B0	B1	B2	...	B21	B22	B23	B24
1		$B21 \oplus B24$	B0	B1	...	B20	B21	B22	B23
2		$B20 \oplus B23$	$B21 \oplus B24$	B0	...	B19	B20	B21	B22
:		:	:	:	...	:	:	:	:
21		$B1 \oplus B4$	$B2 \oplus B5$	$B3 \oplus B6$...	B0	B1	B2	B3
22		$B0 \oplus B3$	$B1 \oplus B4$	$B2 \oplus B5$...	$B21 \oplus B24$	B0	B1	B2
23		$B21 \oplus B24 \oplus B2$	$B0 \oplus B3$	$B1 \oplus B4$...	$B20 \oplus B23$	$B21 \oplus B24$	B0	B1
24	1	$B20 \oplus B23 \oplus B1$	$B21 \oplus B24 \oplus B2$	$B0 \oplus B3$...	$B19 \oplus B22$	$B20 \oplus B23$	$B21 \oplus B24$	B0

3.3.2.3.3.4 The scrambler shall provide a reset input signal *ScrRes* which initializes the PRBS generator stages with the values defined in table 3-3. The reset mechanism shall be implemented as defined in 3.3.2.3.5.

Table 3-3: Scrambler Reset Definition

<i>ScrRes</i>	X[24:0](t)	Remarks
low		
high	X[0] = 1 X[24:1] = 0	'Initialization pattern'

3.3.2.3.3.5 After a system reset, the PRBS generator shall start with the initialization pattern as defined in table 3-3.

3.3.2.3.4 LPC Encoder

3.3.2.3.4.1 Overview

The LPC encoder operates on blocks of 25 bits that can be seen as a 5-by-5 matrix. The LPC encoder discards *LPCEncIn*[23:16] (legacy implementation detail of the LCT encoding process), maps *LPCEncIn*[15:0] to a 4-by-4-matrix, performs differential encoding, calculates 4 horizontal and 4 vertical parity bits and finally adds one bit of *SysChnDat** to obtain a 5-by-5-matrix-block.

3.3.2.3.4.2 Input mapping

LPCEncIn[15:0] and *SysChnDat** shall be mapped to a 5-by-5-input matrix as shown in figure 3-2.

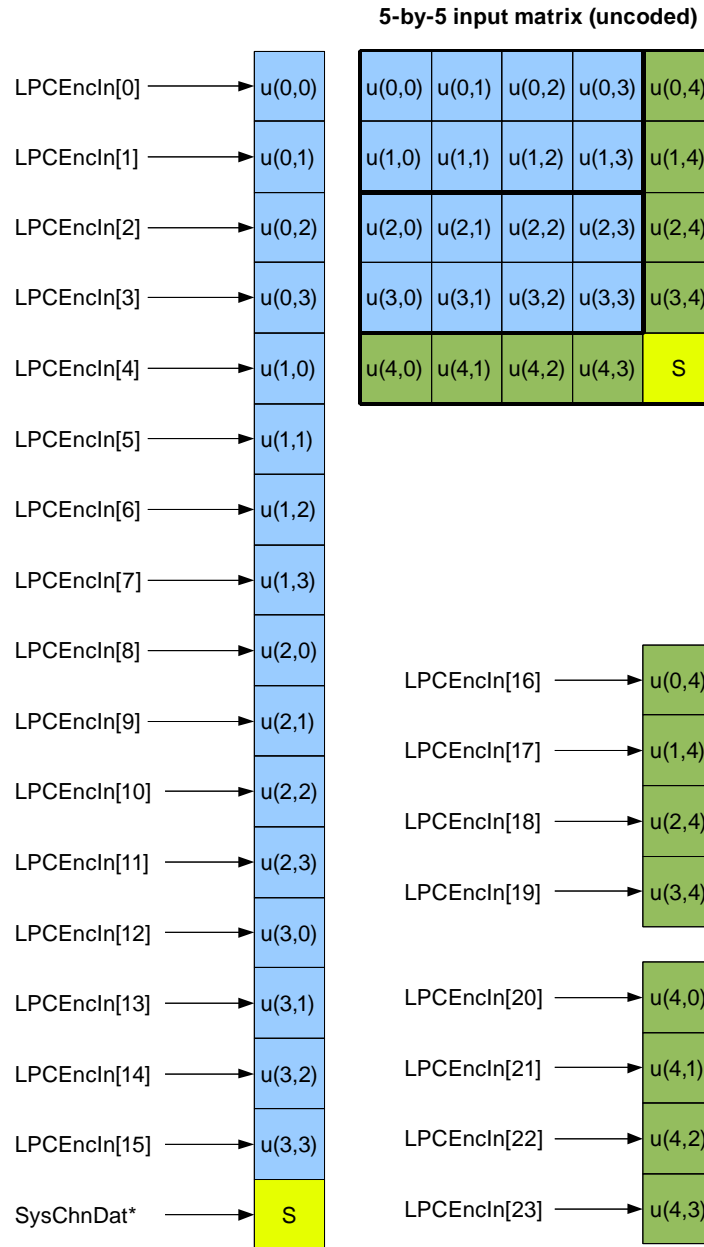

Figure 3-2: Mapping of LPC Encoder Input to 5-by-5 Input Matrix

3.3.2.3.4.3 Output Mapping

The 5-by-5 output matrix shall be mapped to the outputs *DataOut*[24:0] as shown in figure 3-3.

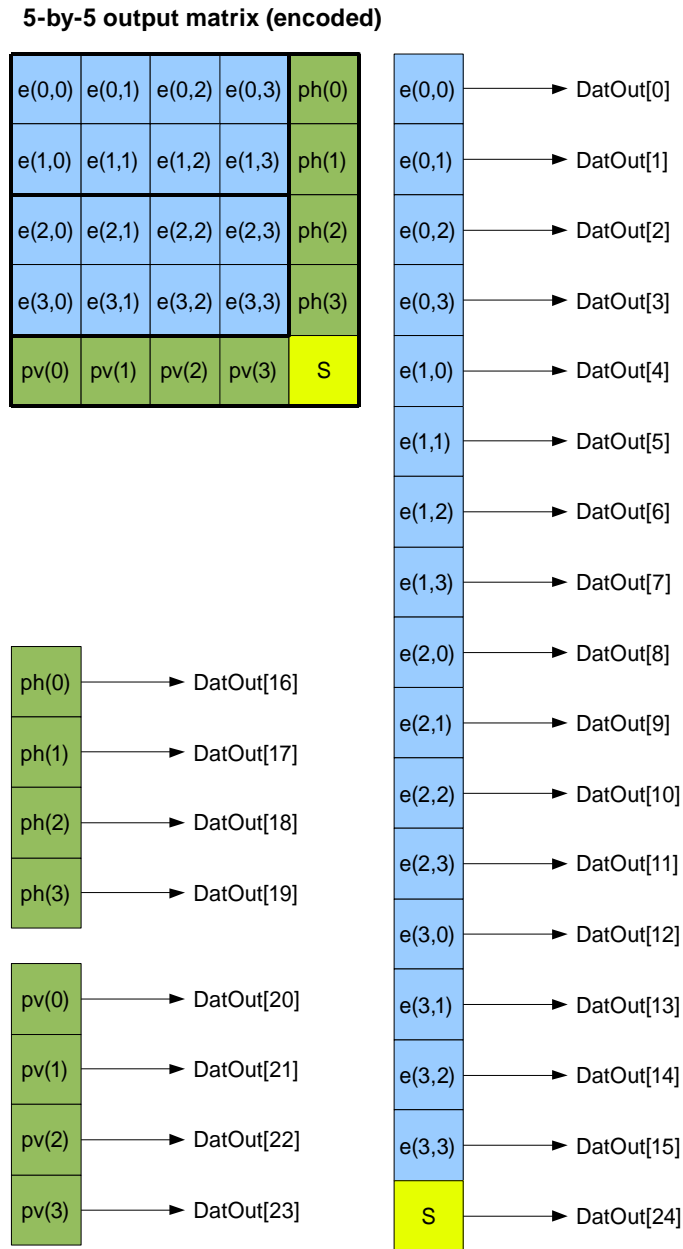

Figure 3-3: Mapping of 5-by-5 Output Matrix to Encoder Output

3.3.2.3.4.4 Differential Encoding

3.3.2.3.4.4.1 General

$e(0,0)$ to $e(3,3)$ shall be calculated according to equation (3).

NOTE – The calculation is also illustrated in figure 3-4.

$$\begin{aligned}
 e(0,0) &= u(0,0) \\
 e(0,1) &= u(0,1) \oplus e(0,0) = u(0,1) \oplus u(0,0) \\
 e(0,2) &= u(0,2) \oplus e(0,1) = u(0,2) \oplus u(0,1) \oplus u(0,0) \\
 e(0,3) &= u(0,3) \oplus e(0,2) = u(0,3) \oplus u(0,2) \oplus u(0,1) \oplus u(0,0) \\
 e(1,0) &= u(1,0) \oplus e(0,3) = u(1,0) \oplus u(0,3) \oplus u(0,2) \oplus u(0,1) \oplus u(0,0) \\
 e(1,1) &= u(1,1) \oplus e(1,0) = u(1,1) \oplus u(1,0) \oplus u(0,3) \oplus u(0,2) \oplus u(0,1) \oplus u(0,0) \\
 e(1,2) &= u(1,2) \oplus e(1,1) = u(1,2) \oplus u(1,1) \oplus u(1,0) \oplus u(0,3) \oplus u(0,2) \oplus u(0,1) \oplus u(0,0) \\
 e(1,3) &= u(1,3) \oplus e(1,2) = u(1,3) \oplus u(1,2) \oplus u(1,1) \oplus u(1,0) \oplus u(0,3) \oplus u(0,2) \oplus u(0,1) \oplus u(0,0)
 \end{aligned}$$

$$\begin{aligned}
 e(2,0) &= u(2,0) \\
 e(2,1) &= u(2,1) \oplus e(2,0) = u(2,1) \oplus u(2,0) \\
 e(2,2) &= u(2,2) \oplus e(2,1) = u(2,2) \oplus u(2,1) \oplus u(2,0) \\
 e(2,3) &= u(2,3) \oplus e(2,2) = u(2,3) \oplus u(2,2) \oplus u(2,1) \oplus u(2,0) \\
 e(3,0) &= u(3,0) \oplus e(2,3) = u(3,0) \oplus u(2,3) \oplus u(2,2) \oplus u(2,1) \oplus u(2,0) \\
 e(3,1) &= u(3,1) \oplus e(3,0) = u(3,1) \oplus u(3,0) \oplus u(2,3) \oplus u(2,2) \oplus u(2,1) \oplus u(2,0) \\
 e(3,2) &= u(3,2) \oplus e(3,1) = u(3,2) \oplus u(3,1) \oplus u(3,0) \oplus u(2,3) \oplus u(2,2) \oplus u(2,1) \oplus u(2,0) \\
 e(3,3) &= u(3,3) \oplus e(3,2) = u(3,3) \oplus u(3,2) \oplus u(3,1) \oplus u(3,0) \oplus u(2,3) \oplus u(2,2) \oplus u(2,1) \oplus u(2,0)
 \end{aligned} \tag{3}$$

where \oplus = logical XOR.

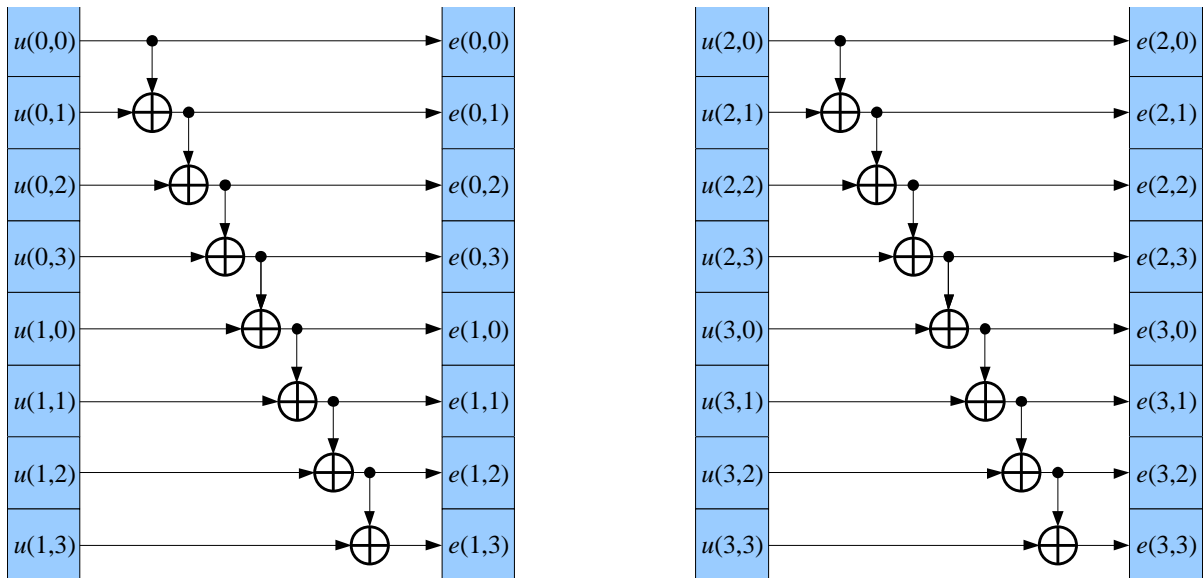

Figure 3-4: Calculation of $e(0,0)$ to $e(3,3)$

3.3.2.3.4.4.2 Horizontal Parity

3.3.2.3.4.4.2.1 The LPC encoder shall determine the horizontal parity bits $ph(0)$ to $ph(3)$.

3.3.2.3.4.4.2.2 $ph(0)$ shall always be calculated for odd parity; that is,

$$\left[ph(0) + \sum_{k=0}^3 e(0,k) \right] \bmod 2 = 1$$

where ‘mod 2’ signifies the remainder after division by 2.

3.3.2.3.4.4.2.3 If $e(0,0) = 0$, odd parity shall be used for $ph(1)$, $ph(2)$ and $ph(3)$; that is,

$$\left[ph(1) + \sum_{k=0}^3 e(1,k) \right] \bmod 2 = \left[ph(2) + \sum_{k=0}^3 e(2,k) \right] \bmod 2 = \left[ph(3) + \sum_{k=0}^3 e(3,k) \right] \bmod 2 = 1.$$

If $e(0,0) = 1$, even parity shall be used for $ph(1)$, $ph(2)$ and $ph(3)$; that is,

$$\left[ph(1) + \sum_{k=0}^3 e(1,k) \right] \bmod 2 = \left[ph(2) + \sum_{k=0}^3 e(2,k) \right] \bmod 2 = \left[ph(3) + \sum_{k=0}^3 e(3,k) \right] \bmod 2 = 0.$$

3.3.2.3.4.4.3 Vertical Parity

3.3.2.3.4.4.3.1 The LPC encoder shall determine the vertical parity bits $pv(0)$ to $pv(3)$.

3.3.2.3.4.4.3.2 $pv(0)$ shall always be calculated for even parity; that is,

$$\left[pv(0) + \sum_{k=0}^3 e(k,0) \right] \bmod 2 = 1$$

where ‘mod 2’ signifies the remainder after division by 2.

3.3.2.3.4.4.3.3 If $e(2,0) = 0$, even parity shall be used for $pv(1)$, $pv(2)$, and $pv(3)$; that is,

$$\left[pv(1) + \sum_{k=0}^3 e(k,1) \right] \bmod 2 = \left[pv(2) + \sum_{k=0}^3 e(k,2) \right] \bmod 2 = \left[pv(3) + \sum_{k=0}^3 e(k,3) \right] \bmod 2 = 0.$$

If $e(2,0) = 1$, odd parity shall be used for $pv(1)$, $pv(2)$, and $pv(3)$; that is,

$$\left[pv(1) + \sum_{k=0}^3 e(k,1) \right] \bmod 2 = \left[pv(2) + \sum_{k=0}^3 e(k,2) \right] \bmod 2 = \left[pv(3) + \sum_{k=0}^3 e(k,3) \right] \bmod 2 = 1.$$

3.3.2.3.4.5 Minimization of Disparity

3.3.2.3.4.5.1 The difference between the number of transmitted ones and zeros, called disparity, shall be determined and eventually varied by bitwise inversion of sub-blocks to minimize the overall disparity. The resulting overall disparity shall be stored in a dedicated memory.

3.3.2.3.4.5.2 The LPC encoder shall use *DisparitySum*[23:0] to store the value of the accumulated disparity.

3.3.2.3.4.5.3 A positive value indicates that more ‘1’s than ‘0’s have been transmitted. A negative value indicates that more ‘0’s than ‘1’s have been transmitted.

3.3.2.3.4.5.4 The LPC encoder shall calculate the disparity DISP1 of subblock 1 of the LPC encoder output matrix according to figure 3-5 and table 3-4.

3.3.2.3.4.5.5 The LPC encoder shall calculate the disparity DISP2 of subblock 2 of the LPC encoder output matrix according to figure 3-5 and table 3-4.

3.3.2.3.4.5.6 The LPC encoder shall calculate the disparity DISP3 of the horizontal and vertical parity bits and S according to figure 3-5 and table 3-4.

e(0,0)	e(0,1)	e(0,2)	e(0,3)	ph(0)
Subblock 1				
e(1,0)	e(1,1)	e(1,2)	e(1,3)	ph(1)
Subblock 2				
e(2,0)	e(2,1)	e(2,2)	e(2,3)	ph(2)
e(3,0)	e(3,1)	e(3,2)	e(3,3)	ph(3)
pv(0)	pv(1)	pv(2)	pv(3)	S

Figure 3-5: Definition of Subblocks within 5-by-5 Output Matrix

Table 3-4: Disparity Calculation

Number of '1's in subblock	Number of '0's in subblock	Disparity Value
<i>m</i>	<i>n</i>	<i>m-n</i>
<i>E.g., for DISP1 and DISP2:</i>		
8	0	8
7	1	6
6	2	4
5	3	2
4	4	0
3	5	-2
2	6	-4
1	7	-6
0	8	-8
<i>E.g., for DISP3:</i>		
9	0	9
8	1	7
7	2	5
6	3	3
5	4	1
4	5	-1
3	6	-3
2	7	-5
1	8	-7
0	9	-9

NOTE – As can be seen from table 3-4, according to this definition of disparity, a bitwise inversion of subblock 1 or subblock 2 results in inverse values of DISP1 or DISP2, respectively.

3.3.2.3.4.5.7 The LPC encoder shall calculate the sums *DispSum*[1], *DispSum*[2], *DispSum*[3] and *DispSum*[4] according to the following equation (4).

$$\begin{aligned}
 \text{DispSum}[1] &= + \text{DISP1} + \text{DISP2} + \text{DISP3} && \text{No subblock inversion} \\
 \text{DispSum}[2] &= - \text{DISP1} + \text{DISP2} + \text{DISP3} && \text{Inversion of subblock 1} \\
 \text{DispSum}[3] &= + \text{DISP1} - \text{DISP2} + \text{DISP3} && \text{Inversion of subblock 2} \\
 \text{DispSum}[4] &= - \text{DISP1} - \text{DISP2} + \text{DISP3} && \text{Inversion of both subblocks}
 \end{aligned} \tag{4}$$

3.3.2.3.4.5.8 Depending on the chosen ‘winner’ (see equations (5) and (6)), the LPC encoder shall possibly invert none, one, or both subblocks of the corresponding LPC block as defined in table 3-5.

Table 3-5: Definition of Subblock Inversion

Winner(<i>t</i>)	Inversion of Subblock 1 corresponding to time <i>t</i>	Inversion of Subblock 2 corresponding to time <i>t</i>
<i>DispSum</i> [0]	no	no
<i>DispSum</i> [1]	yes	no
<i>DispSum</i> [2]	no	yes
<i>DispSum</i> [3]	yes	yes

3.3.2.3.4.5.9 The Winner of the four *DispSum*[1..4] cases shall be selected by minimum of the absolute value of *DisparitySum*[1..4]:

$$DisparitySum[0\dots3](t) = DisparitySum(t) + DispSum[0\dots3](t). \quad (5)$$

3.3.2.3.4.5.10 The new *DisparitySum* shall then be calculated as

$$DisparitySum(t+1) = DisparitySum(t) + DispSum[Winner](t). \quad (6)$$

3.3.2.3.4.5.11 If inversion of subblock 1 is required, this inversion shall be performed bitwise according to equation (7):

$$e(j,k) \in \{0,1\} \Rightarrow \text{Inversion of subblock 1} \Leftrightarrow e(j,k) = \overline{e(j,k)} = 1 - e(j,k) \quad \text{for } j \in \{0,1\}, k \in \{0,1,2,3\}. \quad (7)$$

3.3.2.3.4.5.12 If, according table 3-5, inversion of subblock 2 is required, the inversion shall be performed bitwise according to equation (8):

$$e(j,k) \in \{0,1\} \Rightarrow \text{Inversion of subblock 2} \Leftrightarrow e(j,k) = \overline{e(j,k)} = 1 - e(j,k) \quad \text{for } j \in \{2,3\}, k \in \{0,1,2,3\}. \quad (8)$$

3.3.2.3.4.5.13 *DisparitySum*[23:0] shall be set to 000000_{HEX} whenever encoding is disabled, that is, whenever *EncodingOn* is ‘high’.

3.3.2.3.4.5.14 On a system reset, *DisparitySum*[23:0] shall be reset to 000000_{HEX}.

3.3.2.3.5 System Channel Builder

3.3.2.3.5.1 Overview

The system channel is used to perform the synchronization of the transmitter and the receiver of the communication partners. The receiver searches a unique word, as a part of the system channel, within the data streams and performs channel reordering and scrambler synchronization depending on the results. The optional service channel is a subchannel of the system channel and enables the linked terminals to exchange data relevant to the system.

3.3.2.3.5.2 System Channel Synchronization Frame

NOTE – The format of the system channel frame is depicted in figure 3-6.

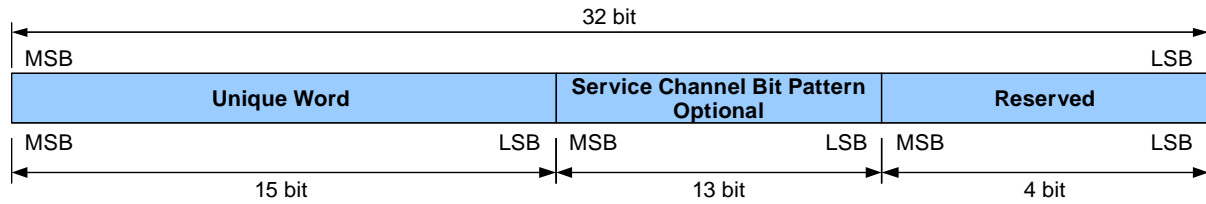

Figure 3-6: System Channel Frame

3.3.2.3.5.2.1 The system channel builder shall generate the frame structure as shown in figure 3-6. The frame shall be transmitted as the 25th data channel. This channel will be further referenced as system channel *SysChnDat*.

3.3.2.3.5.2.2 The data rate shall be 112.5 Mb/s, and the clock frequency shall be 112.5 MHz.

3.3.2.3.5.2.3 The unique word shall contain the fixed patterns defined in table 3-6.

Table 3-6: Definition of Unique Word and Reserved Pattern

Field	Pattern
Unique Word [14:0]	100110101111000 _{BIN} = 4D78 _{HEX}
Unique Word [14:0] inverted	011001010000111 _{BIN} = 3287 _{HEX}
Service_Channel_Bit_Pattern[12:0]	encoding as defined in table 3-8
Reserved	0000 _{BIN} = 0 _{HEX}

3.3.2.3.5.2.4 The scrambler (i.e., the PRBS generator) shall be reset after each 4095 (!) system channel frame.

3.3.2.3.5.2.5 The scrambler shall evaluate the optional signal *ScrResShort* that sets the system channel builder into short scrambler reset mode. In this mode, the scrambler (i.e., the PRBS generator) shall be reset every 9 system channel frames.

NOTE – Table 3-7 defines the logic levels for the *ScrResShort* signal.

Table 3-7: Short Scrambler Reset Mode Definition

<i>ScrResShort</i>	Number of system channel frames between 2 <i>ScrRes</i> signals
low	4095
high	9

3.3.2.3.5.2.6 The reset of the scrambler shall be performed without loss of data; that is, the reset must be performed between two subsequent data samples. If the reset occurs between

time index $t-1$ and time index t , the data $ScrIn[23:0](t-1)$ shall be scrambled with the state of the scrambler at time index $t-1$, and the data $ScrIn[23:0](t)$ shall be scrambled with the reinitialized state of the scrambler.

3.3.2.3.5.2.7 The initialization of the scrambler shall be indicated by the insertion of the inverted unique word in the system channel frame. The reset of the scrambler’s PRBS generator shall be performed 36 system channel bits after the last bit of the inverted unique word.

NOTE – Figure 3-7 shows the timing. This entails that every 4095th unique word (or every 9th unique word when in short scrambler reset mode) of the system channel has to be inverted.

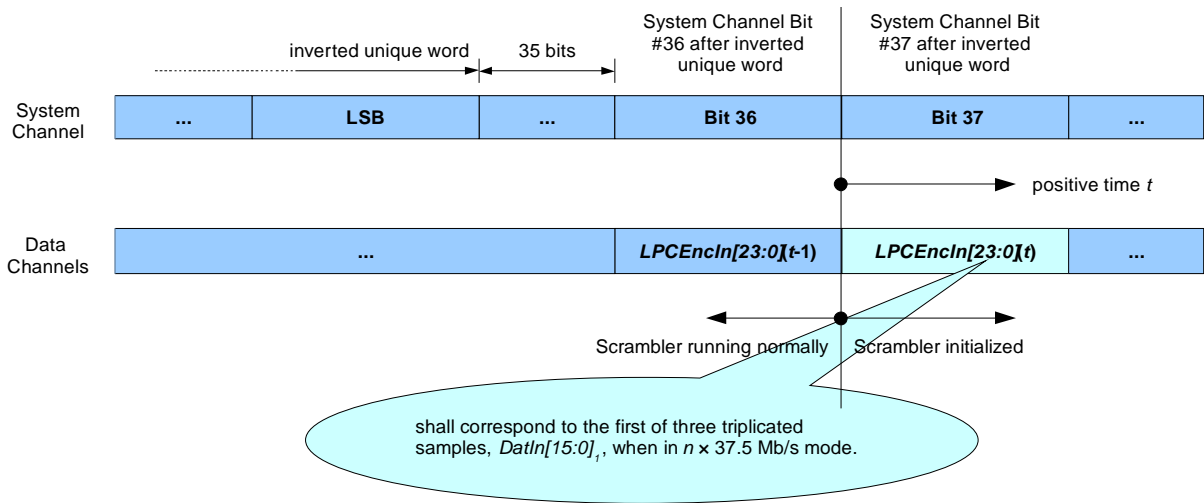

Figure 3-7: Insertion of Inverted Unique Word, Scrambler Reset and Alignment of 3-Tuples

3.3.2.3.5.2.8 The service channel bit pattern field (cf. figure 3-6) shall be used to transmit a single bit of the service channel frame. The encoding is defined in table 3-8.

Table 3-8: Service Channel Bit Encoding

Service channel bit	Service channel bit pattern
0 ('low')	000000000000 _{BIN} (i.e., 0000 _{HEX})
1 ('high')	111111111111 _{BIN} (i.e., 1FFF _{HEX})

3.3.2.3.5.2.9 After a system reset, the system channel builder shall start with a new system channel frame. The first frame shall contain an inverted unique word.

3.3.2.3.6 Optional Service Channel Frame

NOTE – The format of the service channel frame is shown in figure 3-8.

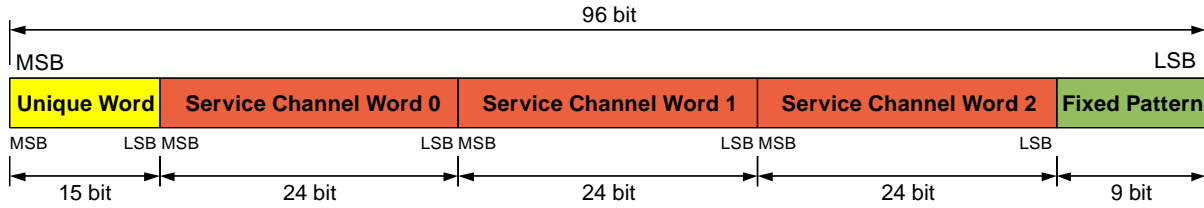

Figure 3-8: Format of Service Channel Frame

3.3.2.3.6.1 General

3.3.2.3.6.1.1 The unique word field shall always contain the unique word as defined in table 3-6.

NOTE – The service channel field carries a 24 bit service channel word that has to be transmitted over the service channel.

3.3.2.3.6.1.2 All three service channel word fields shall contain the same service channel word; that is, service channel words 0, 1, and 2 in figure 3-8 are identical.

3.3.2.3.6.1.3 The last 9 bits of the service channel frame are reserved for future use and shall be set to 155HEX, or 101010101BIN.

3.3.2.3.6.1.4 Each time a service channel frame has been transmitted, a new service channel word shall be requested from the service channel FiFo, to build the next frame.

3.3.2.3.6.1.5 After a system reset, the system channel builder shall start with a new service channel frame.

3.3.2.3.6.2 Differential Encoder

The differential encoder shall apply the following encoding to the system channel data *SysChnDat*:

$$SysChnDat^*(t) = SysChnDat(t) \text{ XOR } SysChnDat^*(t - 1)$$

(*t* = time index).

NOTE – The value of the state memory within the differential encoder will be low after a system reset.

3.3.2.3.7 Serializer 25/1

3.3.2.3.7.1 The Serializer shall convert the 25 parallel bits *DataOut*[24:0] to one serial bitstream *DatSerOut*.

3.3.2.3.7.2 The data bits in the serial output stream shall be sorted as follows: The first bit in the serial data stream shall come from *DataOut*[0], the second bit shall come from *DataOut*[1], and so on. This will continue until 24th data bit. That data bit will appear as the second data bit from *DataOut*[0], and the process will repeat itself.

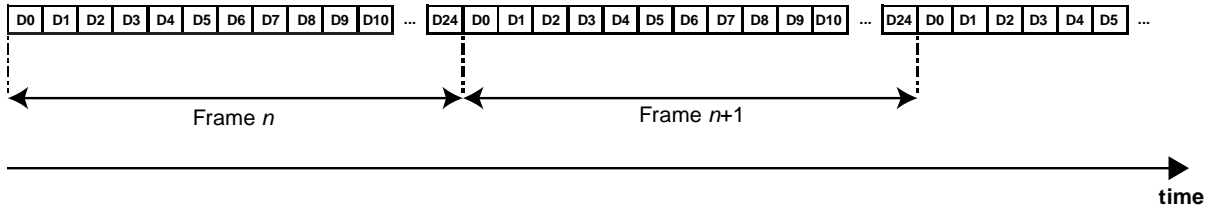

Figure 3-9: Serial Output Data Frame *DatSerOut*

3.3.2.4 Spectral Mask (LPC)

NOTE – The following specification ensures that the optical transmitter will remain within the safe operating envelope of the optical amplifier.

The modulating base-band spectrum of the transmit signal shall fulfill the spectral mask defined in figure 3-10. This spectrum shall be generated by the Line Product Code (LPC) as defined above.

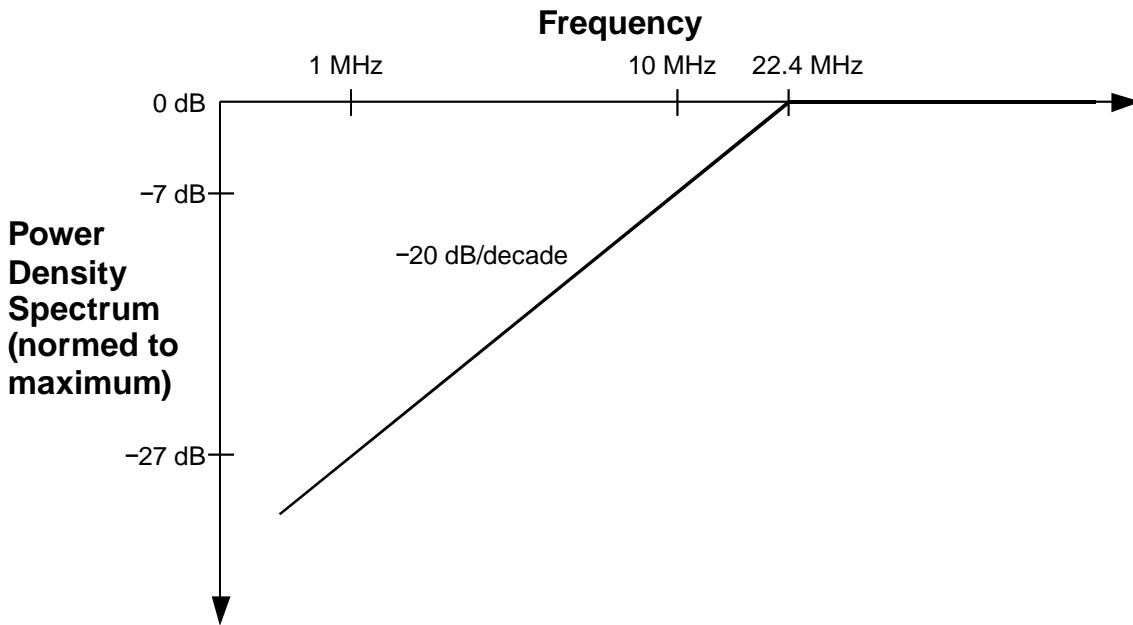

Figure 3-10: Spectral Mask of the Modulated Base-Band Tx Signal

3.3.2.5 Pulse Shape/Eye Diagram

The base-band eye-pattern shall fulfill the requirements listed in table 3-1 and as defined by figure 3-11.

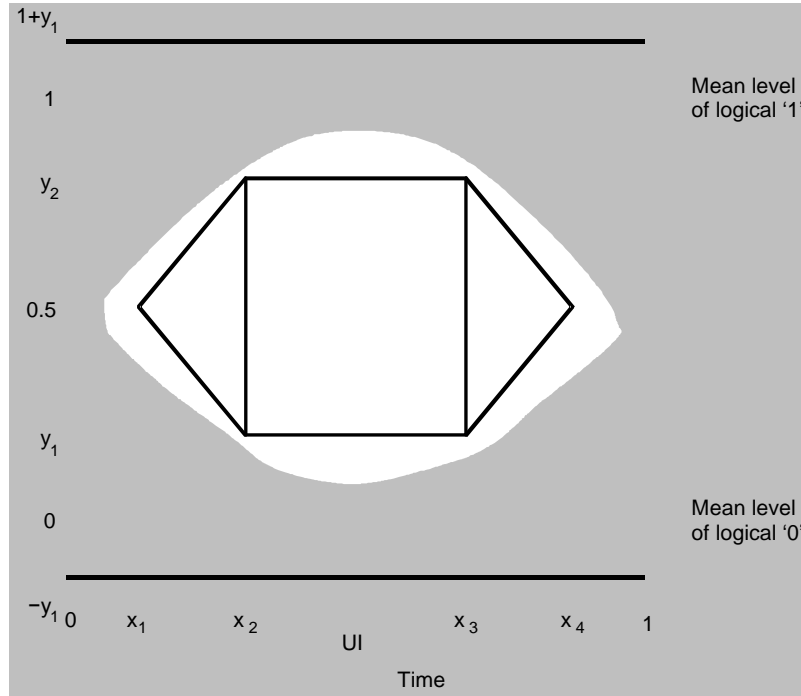

Figure 3-11: Transmit Eye Pattern

Table 3-9: Definitions for the Transmit Eye Pattern in Figure 3-11

Symbol	Definition
UI (Unit Interval)	1 / 2812.5 Mb/s ($\approx 355.55/s$)
x_1	$0.1 \times UI$
x_2	$0.15 \times UI$
x_3	$0.85 \times UI$
x_4	$0.9 \times UI$
y_1	$0.10 \times \text{mean level of logical 1}$
y_2	$0.90 \times \text{mean level of logical 1}$

NOTE – There are no specific requirements for the Pulse Repetition Rate, Accuracy, and Stability (e.g., jitter), and the Extinction Ratio and Data Rates (Range of Rates, Discrete Set, etc.).

3.4 TERMINAL B OPTICAL COMMUNICATIONS SIGNAL CHARACTERISTICS

3.4.1 CENTER FREQUENCIES

The center frequency shall be 281566.0 GHz \pm 3 GHz.

NOTE – The requirements for the Laser Tuning Range, Laser Tuning Range Rate, Laser Line Width, Laser Relative Intensity Noise, Laser Frequency Noise, and Laser Phase Noise are the same as for Terminal A.

3.4.2 POLARIZATION

3.4.2.1 Polarization Type

The transmit beam shall have an RCP, where the E-vector rotates *clockwise* as viewed from the transmitter in the direction of propagation.

3.4.2.2 Polarization Extinction Ratio

The polarization extinction ratio shall be the same as for Terminal A.

3.4.3 MODULATION

The modulation shall be the same as for Terminal A.

4 CODING AND SYNCHRONIZATION

4.1 TERMINAL A DATA LINK LAYER CHARACTERISTICS

4.1.1 SUPPORT OF VARIABLE DL THROUGHPUT

Although the OISL is operated with a fixed data rate, the concept of the LIA=LIAU shall support variable (i.e., selectable or adaptive) data rates on the DL.

NOTE – This is achieved by stuffing with idle frames which are removed in the GEO relay. Some details are shown in the next two figures; the first figure provides an overview in terms of data rates.

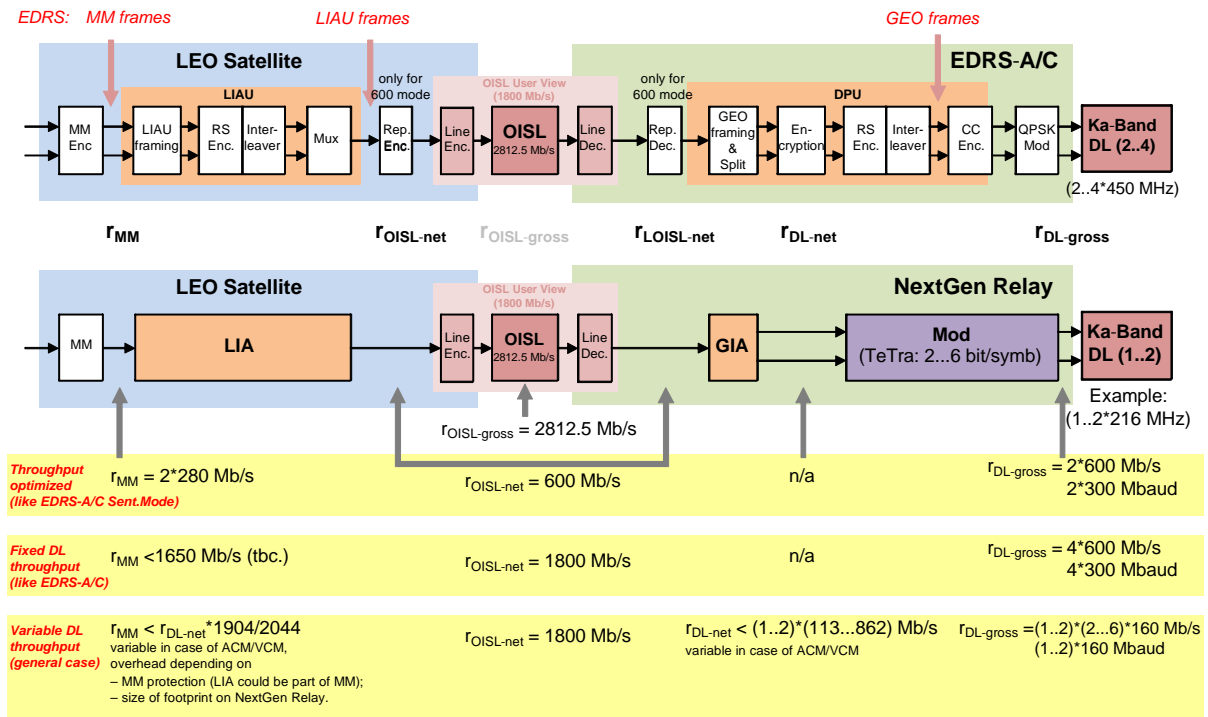

Figure 4-1: Data Rates in Flexible Relay Network

DISCLAIMER – For the general case with variable throughput, a bandwidth of 216 MHz and TeTra modulator are assumed. These are just examples and are not intended to represent Globenet.

4.1.2 FRAME STRUCTURE, SLICER, AND HEADER WITHIN LIA

4.1.2.1 The input data to LIA shall be divided into blocks of 1904 bytes. A header of 8 bytes shall be added, resulting in $1904+8 = 1912 = 8 \times 239$ bytes.

4.1.2.2 The header structure is in a proprietary format and shall be constructed as follows:

- 1 byte for frame type and source ID;
 - bits for frame type (full data frame, partly filled data frame, idle frame for removal in GEO, idle frame for forwarding in GEO),
 - bits for Source ID and idle frame tagging;
- 1 byte for S/C ID;
- 1 byte for cyclic counter (per frame type and source ID), provides a period of about >10 hours at 1800 Mb/s and supports GS diversity;
- 14 bits for PN pointer (position of first filling bit in case of partly filled data frames);
- spare bits.

	Bit 1	Bit 2	Bit 3	Bit 4	Bit 5	Bit 6	Bit 7	Bit 8
Byte 1	Frame type ID		Data source ID					
Byte 2	Spacecraft ID							
Byte 3	Cyclic frame counter							
Byte 4								
Byte 5								
Byte 6								
Byte 7	PN pointer							
Byte 8	PN pointer						Spare	

Figure 4-2: LIA Frame Header for the General Case

NOTES

- 1 This header matches neither the TM Header defined in reference [3] (see figure 4-2 of reference [3], ‘Transfer Frame Primary Header’), nor the AOS Header defined in reference [5] (see figure 4-2 of reference [5], ‘Transfer Frame Primary Header’).
- 2 Figure 4-3 shows the specific case of LIA=DRAU and EDRS-A/C application, where $N=1$ for the number of input sources. The frame header could be the same as in the general case; however, the specific header was selected at the time of the EDRS-A/C design, as shown below.

	Bit 1	Bit 2	Bit 3	Bit 4	Bit 5	Bit 6	Bit 7	Bit 8
Byte 1	Cyclic frame counter							
Byte 2								
Byte 3	PN pointer							
Byte 4	PN pointer						Spare	
Byte 5	Frame type ID	Spare						
Byte 6	Spare							
Byte 7								
Byte 8								

Figure 4-3: LIA Frame Header for the Specific Case of LIA=DRAU

4.1.2.3 Idle frames are characterized by the source ID field of the header. The data content of idle frames shall be fixed and identical for all idle frames.

4.1.2.4 Idle frames shall be filled by a pseudo-random sequence generated by the polynomial

$$h(x) = x^{14} + x^{13} + x^8 + x^4 + 1.$$

4.1.2.5 This sequence shall begin at the first bit of the data block.

NOTE – Since the sequence is longer than $1910 \times 8 = 15280$ bits, the rest of the sequence is not used.

4.1.2.6 The sequence generator shall be initialized to the ‘all-ones’ state at the start of idle frame.

4.1.3 DISCUSSION—NOTES ON RECEIVER OPERATION

The receiver has to identify between frames from different sources and idle frames.

The discrimination between different sources is based on the source ID, but is additionally supported by the source-individual frame counters.

The determination between data frames and idle frame is based on the source ID, but additionally supported by the statistical properties of the known and constant idle data.

4.1.4 CHANNEL CODING, INTERLEAVING, AND SCRAMBLING WITHIN LIA

4.1.4.1 Reed-Solomon Encoding

NOTE – The channel coding (error-control coding) of LIA frames is based on Reed-Solomon (R-S) codes and byte-wise interleaving over 8 R-S codewords that encompass exactly one LIA frame. This is a standard and well-known coding scheme for channels with long burst errors. Such burst-error structures occur, for instance, in cases of concatenated coding at the output of an inner decoder.

The block of frame header and data field containing $1912 = 8 \times 239$ bytes in total shall be R-S encoded.

NOTE – The ASM field is not encoded.

4.1.4.2 Discussion

The 1912 bytes are divided into 8 blocks (denoted R-S infowords) of length 239 bytes. These infowords are individually R-S encoded. The R-S(255,239) encoder computes for each R-S infoword 16 parity-check bytes (systematic encoding). In total, $8 \times 16 = 128$ parity-check bytes are appended to the R-S infowords resulting in a block of $1912 + 128 = 2040$ bytes.

The operation of the R-S(255,239) encoder is specified in detail in section 4 of CCSDS 131.0-B-3 (reference [2]). Only the mode with 239 information bytes and blocklength 255 (implying minimum distance = 17, number of parity-check bytes = 16, number of correctable byte errors = $E = 8$) is used here. The Galois field GF(256) is generated by the polynomial

$$F(x) = x^8 + x^7 + x^2 + x + 1.$$

Let α be a primitive element, $F(\alpha) = 0$. The generator polynomial is defined as

$$g(x) = \prod_{j=128-E}^{127+E} (x - \alpha^{11j}).$$

The interleaving operation with depth $I=8$ is also specified in section 4 of reference [2]. The interleaving is on a per-byte basis. The interleaving is applied within a LIA frame, there is no interleaving over several LIAU superframes. The interleaving depth $I=8$ and number of codewords per LIAU superframe is identical, and none of the codewords is shortened.

The block of 2040 bytes is subjected to additive scrambling (also called randomizing); that is, the complete LIA frame (except the ASM field) is scrambled by modulo-2 adding of a pseudo-random sequence. The pseudo-random sequence shall be generated using the polynomial

$$h(x) = x^8 + x^7 + x^5 + x^3 + 1$$

according to subsection 10.4 of reference [2]. This sequence begins at the first bit of the data block of 2040 bytes after interleaving. The sequence is repeated after 255 bits, continuing repeatedly until the end of the block. The sequence generator is initialized to the all-ones state at the start of LIA frame.

4.1.4.3 Frame Synchronization Marker within LIA

4.1.4.3.1 After scrambling, an ASM field shall be added to end up with an output frame of $2040 + 4 = 2044$ bytes.

4.1.4.3.2 The ASM field shall be 1A CF FC 1D in hexadecimal notation according to subsection 9.3 of reference [2].

4.1.4.4 Multiplexing within LIA

The multiplexer shall operate on $N+1$ chains, where the first N chains are served on a first-come-first-transmit basis, and the idle frames from the last chain have lowest priority (i.e., are inserted and transmitted only to increase the data rate to *ROISL-net*).

NOTE – This operation is termed a stuffing operation.

4.1.4.5 Mapping (Bit-Byte Conversions) within LIA

All operations within LIA shall be byte-oriented.

4.2 TERMINAL B DATA LINK LAYER CHARACTERISTICS

Terminal B characteristics shall be the same as those of Terminal A.

ANNEX A

SECURITY, SANA, AND PATENT CONSIDERATIONS

(INFORMATIVE)

A1 SECURITY CONSIDERATIONS

A1.1 SECURITY BACKGROUND

It is assumed that security is provided by encryption, authentication methods, and access control to be performed at a layer above the Physical Layer and coding sublayer. Mission and service providers are expected to select from recommended security methods, suitable to the specific application profile. Specification of these security methods and other security provisions is outside the scope of this Experimental Specification. The Physical Layer has the objective of delivering data with the minimum possible amount of residual errors. The associated channel coding, as described in section 4 above, must be used to insure that residual errors are detected and the frame flagged. There is an extremely low probability of additional undetected errors that may escape this scrutiny. These errors may affect the encryption process in unpredictable ways, possibly affecting the decryption stage and producing data loss, but will not compromise the security of the data.

A1.2 SECURITY CONCERNS

Security concerns in the areas of data privacy, authentication, access control, availability of resources, and auditing are to be addressed in higher layers and are not related to this Experimental Specification.

A1.3 CONSEQUENCES OF NOT APPLYING SECURITY

There are no specific security measures prescribed for the Physical Layer or the coding sublayer. Therefore consequences of not applying security are only imputable to the lack of proper security measures in other layers. Residual undetected errors may produce additional data loss when the link carries encrypted data.

A2 SANA CONSIDERATIONS

The recommendations of this document do not require any action from SANA.

A3 PATENT CONSIDERATIONS

No patents are known to relate to this Experimental Specification.

ANNEX B

PHYSICAL LAYER AND CODING AND SYNCHRONIZATION SUBLAYER IMPLEMENTATION

(INFORMATIVE)

The Experimental Specification described in this document is fully implemented and operational in the joint ESA and Airbus SpaceDataHighway, which employs the LCT 135 optical communication terminals manufactured by TESAT Spacecom on the EDRS-A satellite launched in 2016.

The Sentinel-1 and Sentinel-2 satellites of the European Union's Copernicus program also carry an LCT and are currently using the EDRS-A relay satellite to transfer high volume data to ground at a data rate of 1.8 Gb/s:

- First tests for optical inter-satellite links with Sentinel satellites and EDRS-A started in early 2016.
- The operational service started in late 2016 with Sentinel-1A.
- As of January 2018 all four Sentinel satellites are served by EDRS-A, and more than 18,000 links have been performed up to October 2018.

ANNEX C

ABBREVIATIONS AND ACRONYMS

(INFORMATIVE)

<u>Term</u>	<u>Meaning</u>
ASM	attached synchronization marker
BPSK	binary phase-shift keying
CADU	channel access data unit
DL	downlink
DRAU	data rate adaptation unit
EDRS	European Data Relay System
Gb/s	gigabits per second
GEO	geostationary orbit
HDR	high data rate
kb/s	kilobits per second
LCP	left-hand circular polarization
LCT	laser communication terminal
LEO	low Earth orbit
LIA	LCT interface adapter
LIAU	LCT interface adapter unit
LPC	line product code
Mb/s	megabits per second
OISL	optical inter-satellite link
PAT	pointing, acquisition, and tracking
PRBS	pseudorandom binary sequence
QPSK	quadrature phase-shift keying
RCP	right-hand circular polarization
S/C	spacecraft
UC	uncertainty cone